

Service
Service
Service

Service Manual

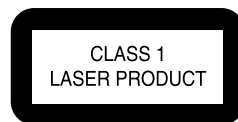

Contents		Page	
1	Technical Specs and Connection Facilities		2
2	Safety Instructions, Warnings, Notes, and Service Hints		4
3	Directions for Use		6
4	Mechanical- and Dismantling Instructions		19
5	Diagnostic Software, Trouble Shooting and Test Instructions		22
6	<i>Wiring-, Block Diagrams</i>		
	Block Diagram		41
	Wiring Diagram		42/43
7	<i>Electrical Diagrams and Print-Layouts</i>		<i>Diagram PWB</i>
	Power Supply Unit		44 45
	AV Board: Video & SCART (Diagram A1)		46 49-52
	AV Board: Audio (Diagram A2)		47 49-52
	AV Board: Regulated Supply (Diagram A3)		48 49-52
	Testpoint Overview		53
	Front DVD723: Display (Diagram D)		54 55-57
	Front DVD723: Standby (Diagram S)		58 58
	Front DVD743: Display (Diagram D)		59 60-62
	Front DVD743: Standby (Diagram S)		63 63
	Switching		64
	SCART		65 66-68
8	Alignments (Not Applicable)		69
9	Circuit Descriptions, List of Abbreviations, and IC Data		69
10	Spare Parts List		74

©Copyright 2002 Philips Consumer Electronics B.V. Eindhoven, The Netherlands.
All rights reserved. No part of this publication may be reproduced, stored in a
retrieval system or transmitted, in any form or by any means, electronic,
mechanical, photocopying, or otherwise without the prior permission of Philips.



PHILIPS

1. Technical Specifications and Connection Facilities

1.1 DVD723/0X1

PLAYBACK SYSTEM

DVD Video
 Video CD & SVCD
 CD (CD-Recordable and CD-Rewritable)
 MP3 CD

TV STANDARD (PAL/50Hz) (NTSC/60Hz)

Number of lines	625	525
Playback	Multistandard	(PAL/NTSC)

VIDEO PERFORMANCE

Video output	1Vpp into 75 ohm
RGB (SCART) output	0.7Vpp into 75 ohm
Black Level Shift	On/Off
Video Shift	Left/Right

AUDIO FORMAT

Digital	MPEG	Compressed
	Dolby Digital	Digital
	PCM	16, 20, 24 bits
		fs, 44.1, 48, 96 kHz

MPEG MP3 MPEG Audio L3
 Analogue Stereo Sound
 Dolby Surround-compatible downmix from Dolby Digital
 multi-channel sound
 3D Sound for virtual 5.1 channel sound on 2 speakers

AUDIO PERFORMANCE

DA Converter	24 bits	
DVD	fs 96 kHz	4 Hz - 44 kHz
DVD/SVCD	fs 48 kHz	4 Hz - 22 kHz
SVCD/VCD/CD	fs 44.1 kHz	4 Hz - 20 kHz
Signal-Noise (1kHz)		> 105 dB
Dynamic Range (1kHz)		> 100 dB
Crosstalk (1kHz)		> 105 dB
Distortion and Noise (1kHz)		> 90 dB
MPEG MP3	MPEG Audio L3	

CONNECTIONS

SCART	Euroconnector
S-Video Output	Mini DIN, 4 pins
Video Output	Cinch (yellow)
Audio L+R output	Cinch (white/red)
Audio Subwoofer	Cinch (black)
Digital Output	1 coaxial, 1 optical
	IEC958 for CDDA / LPCM
	IEC1937 for MPEG1/2, Dolby
	Digital

CABINET

Dimensions (w x h x d)	435 x 75 x 302 mm
Weight	Approximately 2.8 Kg

* typical playing time for movie with 2 spoken languages and 3 subtitle languages

Specifications subject to change without prior notice

1.2 DVD743/0X1

PLAYBACK SYSTEM

DVD Video
 Video CD & SVCD
 CD (CD-Recordable and CD-Rewritable)
 MP3 CD

TV STANDARD (PAL/50Hz) (NTSC/60Hz)

Number of lines 625 525
 Playback Multistandard (PAL/NTSC)

VIDEO PERFORMANCE

Video output 1 Vpp into 75 ohm
 RGB (SCART) output 0.7 Vpp into 75 ohm
 Black Level Shift On/Off
 Video Shift Left/Right

AUDIO FORMAT

Digital	MPEG	Compressed Digital
	Dolby Digital	16, 20, 24 bits
	PCM	fs, 44.1, 48, 96 kHz
MPEG MP3	MPEG Audio L3	

Analogue Stereo Sound
 Dolby Surround-compatible downmix from Dolby Digital multi-channel sound
 3D Sound for virtual 5.1 channel sound on 2 speakers

AUDIO PERFORMANCE

DA Converter	24 bits	
DVD	fs 96 kHz	4 Hz - 44 kHz
DVD/SVCD	fs 48 kHz	4 Hz - 22 kHz
SVCD/VCD/CD	fs 44.1 kHz	4 Hz - 20 kHz
Signal-Noise (1kHz)		> 110 dB
Dynamic Range (1kHz)		> 100 dB
Crosstalk (1kHz)		> 105 dB
Distortion and Noise (1kHz)		> 90 dB
MPEG MP3	MPEG Audio L3	

CONNECTIONS

SCART	2x Euroconnector
S-Video Output	Mini DIN, 4 pins
Video Output	Cinch (yellow)
Audio L+R output	2x Cinch (white/red)
Audio Subwoofer	Cinch (black)
Digital Output	1 coaxial, 1 optical
	IEC958 for CDDA / LPCM
	IEC1937 for MPEG1/2, Dolby Digital

CABINET

Dimensions (w x h x d)	435 x 77.5 x 303.5 mm
Weight	Approximately 2.8 Kg

* typical playing time for movie with 2 spoken languages and 3 subtitle languages

Specifications subject to change without prior notice

2. Safety Instructions, Warnings, Notes, and Service Hints

2.1 Safety Instructions

2.1.1 General Safety

Safety regulations require that during a repair:

- Connect the unit to the mains via an isolation transformer.
- Replace safety components, indicated by the symbol ▲, only by components identical to the original ones. Any other component substitution (other than original type) may increase risk of fire or electrical shock hazard.

Safety regulations require that after a repair, you must return the unit in its original condition. Pay, in particular, attention to the following points:

- Route the wires/cables correctly, and fix them with the mounted cable clamps.
- Check the insulation of the mains lead for external damage.
- Check the electrical DC resistance between the mains plug and the secondary side:
 1. Unplug the mains cord, and connect a wire between the two pins of the mains plug.
 2. Set the mains switch to the 'on' position (keep the mains cord unplugged!).
 3. Measure the resistance value between the mains plug and the front panel, controls, and chassis bottom.
 4. Repair or correct unit when the resistance measurement is less than 1 MΩ.
 5. Verify this, before you return the unit to the customer/user (ref. UL-standard no. 1492).
 6. Switch the unit 'off', and remove the wire between the two pins of the mains plug.

2.1.2 Laser Safety

This unit employs a laser. Only qualified service personnel may remove the cover, or attempt to service this device (due to possible eye injury).

Laser Device Unit

Type	: Semiconductor laser GaAlAs
Wavelength	: 650 nm (DVD) : 780 nm (VCD/CD)
Output Power	: 20 mW (DVD+RW writing) : 0.8 mW (DVD reading) : 0.3 mW (VCD/CD reading)
Beam divergence	: 60 degree

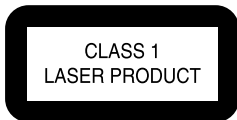

Figure 2-1

Note: Use of controls or adjustments or performance of procedure other than those specified herein, may result in hazardous radiation exposure. Avoid direct exposure to beam.

2.2 Warnings

2.2.1 General

- All ICs and many other semiconductors are susceptible to electrostatic discharges (ESD, ⚡). Careless handling during repair can reduce life drastically. Make sure that, during repair, you are at the same potential as the mass of the set by a wristband with resistance. Keep components and tools at this same potential.
Available ESD protection equipment:
 - Complete kit ESD3 (small tablemat, wristband, connection box, extension cable and earth cable) 4822 310 10671.
 - Wristband tester 4822 344 13999.
- Be careful during measurements in the live voltage section. The primary side of the power supply (pos. 1005), including the heatsink, carries live mains voltage when you connect the player to the mains (even when the player is 'off!'). It is possible to touch copper tracks and/or components in this unshielded primary area, when you service the player. Service personnel must take precautions to prevent touching this area or components in this area. A 'lightning stroke' and a stripe-marked printing on the printed wiring board, indicate the primary side of the power supply.
- Never replace modules, or components, while the unit is 'on'.

2.2.2 Laser

- The use of optical instruments with this product, will increase eye hazard.
- Only qualified service personnel may remove the cover or attempt to service this device, due to possible eye injury.
- Repair handling should take place as much as possible with a disc loaded inside the player.
- Text below is placed inside the unit, on the laser cover shield:

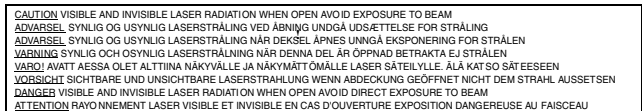

Figure 2-2

2.2.3 Notes

Dolby

Manufactured under licence from Dolby Laboratories. "Dolby", "Pro Logic" and the double-D symbol are trademarks of Dolby Laboratories. Confidential Unpublished Works.
©1992-1997 Dolby Laboratories, Inc. All rights reserved.



Figure 2-3

Trusurround

TRUSURROUND, SRS and symbol (fig 2-4) are trademarks of SRS Labs, Inc. TRUSURROUND technology is manufactured under licence from SRS labs, Inc.



Figure 2-4

2.3 Service Hints

2.3.1 Switched Mode Power Supply

The power supply unit has to be replaced in case of failure. The schematic provided in the manual is only for information and no service parts will be available.

2.3.2 DVD Module

This module can be repaired as follows:

1. The VAL6013/01 is a combination of loading mechanism and DVD-mechanism. Both are not repairable units and in case of failure, it has to be replaced with a new loader VAL6013/01.

Note: When replacing with a new VAL6013/01, two solder joints have to be removed after connecting the OPU flex foil to the mono board.

The solder joints, which shortcircuits the laser diodes to ground, are for protection against ESD. Refer to figures 2-5 and 2-6 for location of solder joints.

2. The mono board has to be repaired down to component level. Repair handling of the monoboard requires a workshop with sophisticated desoldering tools.

VAL6013/01 Solder Joints

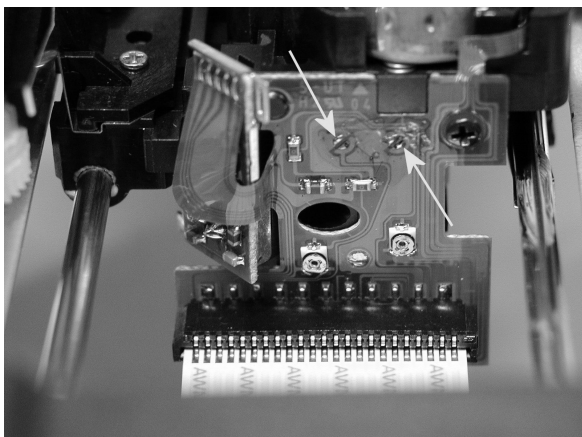

Figure 2-5

VAL6013/01 Solder Joints

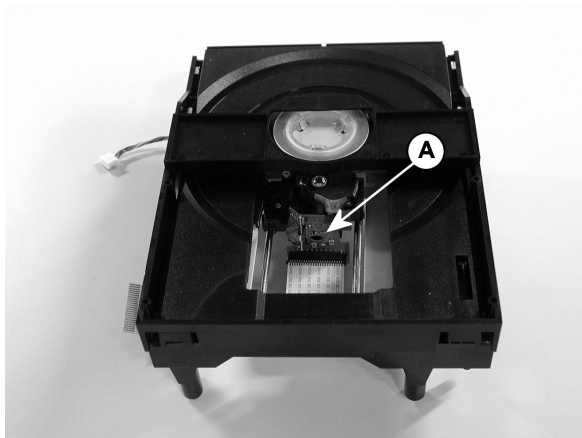

Figure 2-6

2.3.3 ComPair

For assistance with the repair process of the monoboard an electronic fault finding guidance has been developed. This program is called ComPair.

This ComPair program is available on CDROM.

The version of the CDROM for repair of the monoboard is V1.3 or higher and can be ordered with codenumber 4822 727 21637. This is an update CDROM, so when the ComPair CDROM is used for the first time, one has to install the ComPair Engine CDROM V1.2 first.

The V1.2 CDROM can be ordered with code number 4822 727 21634 and has to be registered after installation. The procedure for registration is explained in the help file of the program and in the CDROM booklet.

The cable to connect the monoboard with a PC can be ordered with codenumber: 3122 785 90017.

All the hardware and software requirements of the systems, necessary for working with ComPair, are described on the CDROM.

2.3.4 Service Positions

Refer to dismantling instructions for dismantling of the board. Figures 2-7 to 2-8 shows the service position that are recommended during repair of the boards.

DVD723/0X1 model



Figure 2-7

DVD743/0X1 model

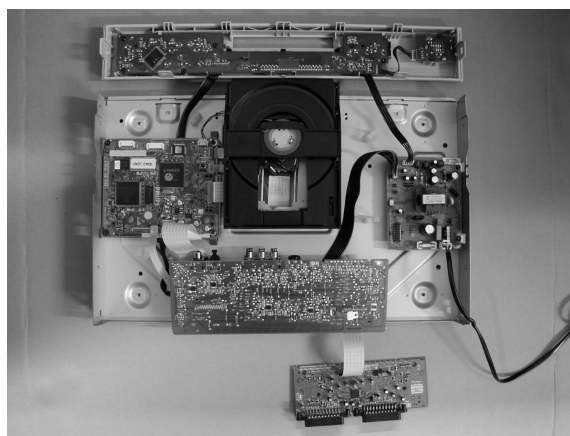

Figure 2-8

3. Directions for Use

General Information

The region code for this set is 2.

Since it is usual for DVD movies to be released at different times in different regions of the world, all players have region codes and discs can have an optional region code. If you load a disc of a different region code to your player, you will see the region code notice on the screen. The disc will not playback and should be unloaded.



Manufactured under license from Dolby Laboratories, "Dolby", "Pro Logic," and the double-D symbol are trademarks of Dolby Laboratories.

This product incorporates copyright protection technology that is protected by method claims of certain U.S. patents and other intellectual property rights owned by Macrovision Corporation and other rights owners. Use of this copyright protection technology must be authorised by Macrovision Corporation, and is intended for home and other limited viewing uses only unless otherwise authorised by Macrovision Corporation. Reverse engineering or disassembly is prohibited.

TruSurround and the  symbol are trademarks of SRS Labs, Inc. TruSurround technology is incorporated under license from SRS Labs, Inc.

 The DVD VIDEO player is in conformity with the EMC directive and low-voltage directive.

For Customer Use:

Read carefully the information located at the bottom of your DVD VIDEO player and enter below the Serial No. Retain this information for future reference.

Model No. DVD VIDEO
Serial No. _____

Important Note

DK

Advarsel:
Laserrudstråling ved åbning når sikkerhedsafbrydere er ude af funktion. Undgå udsættelse for stråling.

Bemærk

Netafbryderen POWER er sekundært indkoblet og afbryder ikke strømmen fra nettet. Den indbyggede nedlader er derfor tilsluttet til lynnettet så lange netstikket sidder i stikkontakten.

N

Observer:
Netafbryderen POWER er sekundært indkoblet. Den indbyggede nedlader er derfor tilsluttet til lynnettet så længe netstikket sidder i stikkontakten.

S

Klass 1 laserapparat
Varning!

Om apparaten används på annat sätt än i denna bruksanvisning specificerats, kann användaren utsättas för laserstrålning som överstiger gränsen för laserklass 1.

Observera!

Strömavbrytaren POWER är sekundärt kopplad och inte bryter strömmen från nätet. Den inbyggda nedladdaren är därför ansluten till elnätet så länge strömproppen sitter i vägguttaget.

SF

Luokan 1 laseriläite + Klass 1 laserapparaatti

Varoitus!

Laitteen käyttäminen muulla kuin tässä käyttöohjeessa mainituilla tavalla saattaa aiheuttaa käyttäjän turvallisuusloukan 1 yrittäville laseritaselle.

Huom.

Tuotteen avoimien POWER on kytketty osittopöytälaite, eikä se kytkä laitteita iri sähköverkossa. Sitä varten on yhdistetty verkko-osaa on kytketty sähköverkkoon aina silloin, kun protekti on pistotulostassa.

Important Note for Users in the UK

Mains plug

This apparatus is fitted with an approved 13 Amp plug. To change a fuse in this type of plug proceed as follows:

1. Remove fuse cover and fuse.
2. Fix new fuse which should be a BS1362, 5 Amp, A.S.T.A. or BSI approved type.
3. Re-fit the fuse cover.

If the fitted plug is not suitable for your socket outlets, it should be cut off and an appropriate plug fitted in its place. If the mains plug contains a fuse, this should have a value of 5 Amp. If a plug without a fuse is used, the fuse at the distribution board should not be greater than 5 Amp.

Note: The severed plug must be disposed of to avoid a possible shock hazard should it be inserted into a 13 Amp socket elsewhere.

How to connect a plug

The wires in the mains lead are coloured with the following code: blue = neutral (N), brown = live (L).

As these colours may not correspond with the colour markings identifying the terminals in your plug, proceed as follows:

- Connect the blue wire to the terminal marked N or coloured black.
- Connect the brown wire to the terminal marked L or coloured red.
- Do not connect either wire to the earth terminal in the plug, marked E (or e) or coloured green (or green and yellow).

Before replacing the plug cover, make certain that the cord grip is clamped over the sheath of the lead - not simply over the two wires.

Copyright in the U.K.

Recording and playback of material may require consent. See Copyright Act 1956 and The Performers' Protection Acts 1958 to 1972.

Laser safety

This unit employs a laser. Due to possible eye injury, only a qualified service person should remove the cover or attempt to service this device.

USE OF CONTROLS OR ADJUSTMENTS OR PERFORMANCE OF PROCEDURES OTHER THAN THOSE SPECIFIED HEREIN MAY RESULT IN HAZARDOUS RADIATION EXPOSURE.

NOTE: PICTURES SHOWN MAYBE DIFFERENT BETWEEN COUNTRIES.

LASER

Type	Semiconductor-laser GaAlAs
Wave length	650 nm (DVD)
	780 nm (VCD/CD)
Output Power	7 mW (DVD)
	10 mW (VCD/CD)
Beam divergence	60 degree

CAUTION (WARNING LOCATION: ON THE BACKPLATE OF SET)

NEVER MAKE OR CHANGE CONNECTIONS WITH THE POWER SWITCHED ON.

Introduction

Thank you for purchasing this Philips DVD player. This Owner's Manual explains the basic operation of this DVD player.

Environmental Information

All unnecessary packaging has been omitted. Packaging has been made easy to separate into three materials: cardboard (box), polystyrene foam (buffer) and polyethylene (bags, protective foam sheet).

Your DVD player consists of materials which can be recycled and reused if disassembled by a specialised company. Please observe the local regulations regarding the disposal of packaging materials, exhausted batteries and old equipment.

Supplied accessories

- Remote control
- Batteries (two AA size) for remote control
- Audio cable
- SCART cable (*not available for all versions*)
- CVBS cable
- Owner's Manual

Safety Information

- Before operating the DVD player, check that the operating voltage indicated on the typeplate (or the voltage indication beside the voltage selector) is identical with the voltage of your local power supply. If not, please consult your dealer.
- Place the DVD player on a flat, hard and stable surface.
- There must be sufficient room in front of the player for the disc tray to be opened.

Front Panel

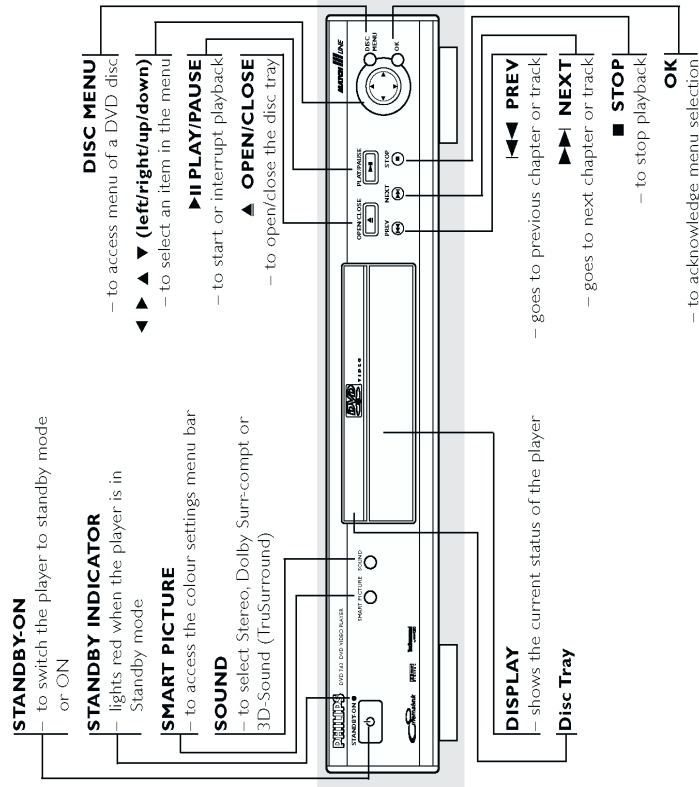

- Helpful Hints!**
- Some DVD video discs require specific functions or allow only limited functions during playback.
 - "X" may appear on the TV screen which means that the function is not available on that specific DVD video disc.

Symbols Used in this Manual

The below symbols appear in some headings and notes with the following meanings:

	- Description refers to playback of DVD-video discs
	- Description refers to playback of Video CDs
	- Description refers to playback of Audio CDs

Functional Overview

Rear Panel

English

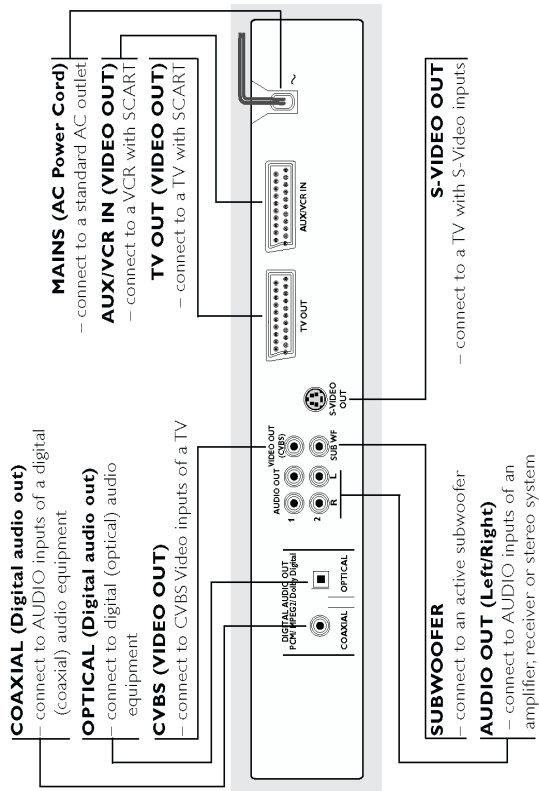

Caution: Do not touch the inner pins of the jacks on the rear panel. Electrostatic discharge may cause permanent damage to the unit.

8

Remote Control

English

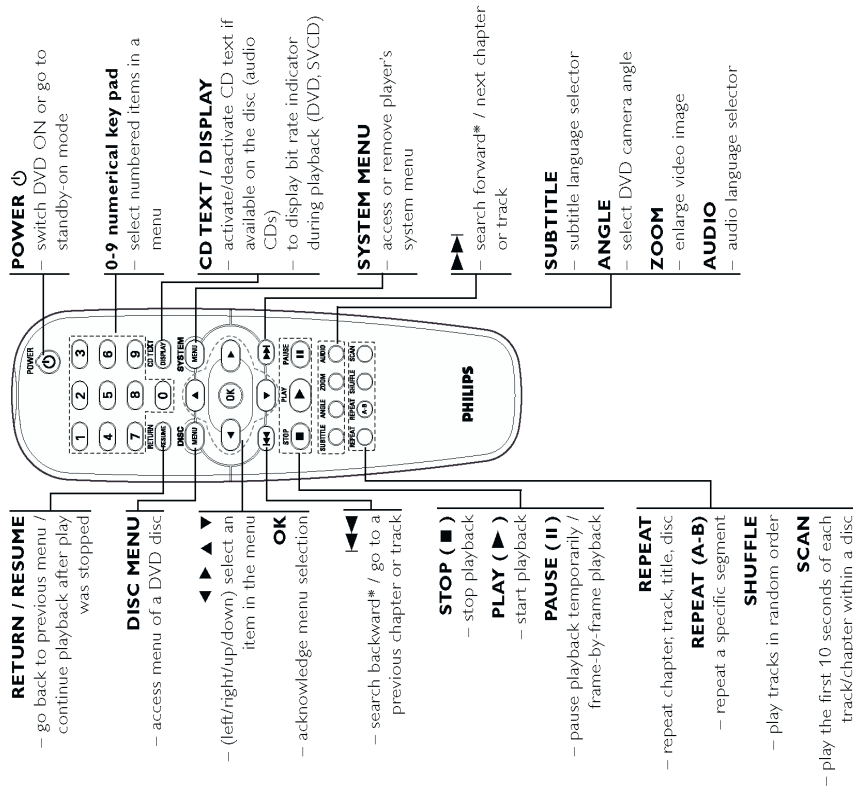

* Press and hold key for about two seconds

9

Preparation

English

Basic Connections

- Please refer to the instruction books of your TV, VCR, Stereo System or other devices as necessary to make the best connections.
- Make one of the following connections, depending on the capabilities of your existing equipment.

The following guidelines are options for the best picture and sound quality available on your DVD player:

- Picture**
 - 1 Use the CVBS Video Output for good picture quality.
 - 2 Use S-Video Output for the better picture quality.
 - 3 Use SCART Output for best picture quality.
- Sound**
 - 1 Digital audio connections provide the clearest sound. Connect the DVD player's DIGITAL AUDIO OUT (either COAXIAL or OPTICAL) to your amplifier or receiver.
 - 2 If digital connections are not possible, connect the DVD player's Left and Right (white and red) AUDIO OUT to your amplifier, receiver, stereo or TV.

- Warning!**
- Never make or change connections with the power switched on.
 - Connect the DVD player directly to your TV, instead of e.g. a VCR, to avoid distortion because DVD video discs are copy protected.
 - Do not connect the DVD player AUDIO OUT to PHONO IN of your amplifier or receiver.

Connecting to a TV

- 1 Connect the SCART (TV OUT) on the DVD player to the corresponding connector on the TV.

Note:

- Ensure that the "TV" indication on SCART cable is connected to the TV set and "DVD" indication on SCART cable is connected to the DVD player.

If your TV is not equipped with a SCART input, you can select the following connection:

If your TV has a CVBS Video input connector,

- 1 Connect the CVBS VIDEO OUT on the DVD player to the CVBS VIDEO IN on the TV.
- 2 Connect the Left and Right AUDIO OUT on the DVD player to the Left and Right AUDIO IN on the TV.

If your TV has a S-Video input connector,

- 1 Connect the S-VIDEO OUT on the DVD player to the S-VIDEO IN on the TV.
- 2 Connect the Left and Right AUDIO OUT on the DVD player to the Left and Right AUDIO IN on the TV.

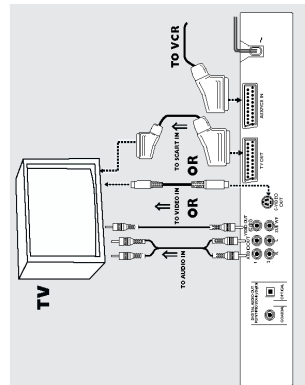

Preparation

English

Connecting to Optional Equipment

- A digital component with a built-in MPEG 2 or Dolby Digital™ decoder allows you to enjoy the surround sound while producing the effect of being in a movie theater or a concert hall.
- The player outputs the surround sound signals from the DIGITAL OUT COAXIAL or OPTICAL connectors.

If your receiver has a MPEG 2 or Dolby Digital™ decoder,

- 1 Connect the COAXIAL or OPTICAL DIGITAL AUDIO OUT of the DVD player to the COAXIAL or OPTICAL DIGITAL AUDIO IN on your receiver.
- 2 You will need to set the DVD player's digital output to ALL (see 'Personal Preferences').

Notes:

- If your receiver has a PCM decoder only, make sure that the Digital Output is set to PCM-only in the 'Personal Preferences' setting.

Cinemalink (on SCART)

This DVD player is equipped with cinemalink feature (from Philips) which allows a more complete control of your home audio/video (AV) equipment.

Cinemalink interconnection plug & playback will enable the AV system to recognise the users intention and automatically switch the necessary controls or input source accordingly. This will reduce the necessity of having multiple control inputs for all AV equipments (eg. TV and Amplifier).

Connecting to an Audio System

- 1 You can also listen to the sound of audio CDs and DVD video discs by connecting to an optional stereo system.
- 2 Connect the Left and Right AUDIO OUT on the DVD player to the Left and Right AUDIO IN on the stereo system.

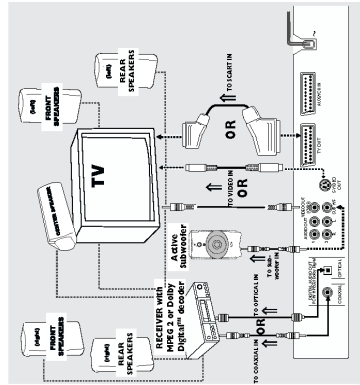
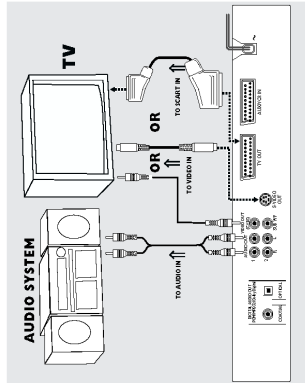

Preparation

If you connect to an active subwoofer,

- 1 Connect the SUBWOOFER AUDIO OUT on the DVD player to an optional active subwoofer.
- 2 The subwoofer reproduces the low bass sound effects (e.g. explosions, the rumble of spaceships, etc.).
- 3 Be sure to follow the instructions supplied with the subwoofer.

Notes:

- If the audio format of the digital output does not match the capabilities of your receiver, the receiver will produce a strong, distorted sound or no sound at all.
- To see the selected audio format of the current DVD in the Status Window, press SYSTEM MENU.
- MP3 Audio is not available on the Digital Output.

Inserting batteries into the Remote Control

- 1 Open the battery cover.
- 2 Insert batteries (AA size) with the correct polarity as indicated by the + and - symbols inside the battery compartment.
- 3 Close the cover.

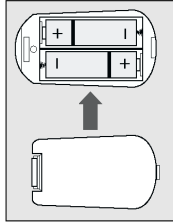

CAUTION!

- Remove batteries if they are exhausted or not to be used for a long time.
- Do not use old and new or different types of batteries in combination.
- Batteries contain chemical substances, so they should be disposed off properly and kept away from children.

Using the Remote Control

- Direct the remote control at the remote sensor of the DVD player.
- Do not drop the remote control.
- Do not leave the remote control near extremely hot or humid place.
- Do not spill water or put anything wet on the remote control.

Preparation

Menu bar 1



From the left,
Personal Preferences → Subtitle Language →
Audio Language → Colour → Sound

Menu bar 2



From the left,
Step by step playback → Slow motion →
Fast motion → Angle → Zoom

Menu bar 3



From the left,
Title → Chapter → Time Search →
Favourite Track Selection (FIS)

Temporary Feedback Field Icons

These icons will appear on the top left hand corner of your TV screen.

scan	h	Repeat A to end
repeat	A B	Repeat A-B
title		Angle
track	track	Child Lock On
chapter	safe	Child Safe
shuffle	return	Resume
shuffle	shuffle	Action Prohibited

NTSC/PAL Conversion

This player is equipped with an NTSC/PAL conversion feature that converts the video output of the disc to match your TV system. To activate the conversion refer to page 15.

Switching On

- 1 Connect the AC power cord to the power outlet.
- 2 Switch on the TV and DVD player.
- 3 Set the TV to the correct Video IN channel (e.g. EXT1, EXT2, AV1, AV2, AUDIO/VIDEO), etc. (Refer to your TV owner's manual for detail) → The player display lights up and the default screen appears on the TV.
- 4 If you are using an external equipment (e.g. audio system or receiver), turn them on and select the appropriate input source that was used to connect to the DVD player output. Refer to the equipment owner's manual for detail.

Menu Bars on TV Screen

- Operations can be carried out directly via the multiple menu bars on the TV screen.
- The following functions are available via the menu bars. Pressing SYSTEM MENU keys repeatedly will toggle through menu bar 1, menu bar 2, menu bar 3 and menu bar OFF.

Preparation

English

Personal Preferences

In the Personal Preferences settings menu, you can customize your player to suit your own particular requirements.

General operation:

- 1 Press SYSTEM MENU on the remote control.
 - 2 The **TV** will be highlighted in the menu bar.
 - 3 Press **▼** to activate the Personal Preferences menu.
 - 4 Use the **◀ ▶ ▲ ▼** keys to toggle through the functions and select your preferred option.
 - 5 Press **OK** to confirm a highlighted selection.
- The following items are available:

Picture

– TV Shape

Select the aspect ratio of the TV to be connected.

16:9 → when you connect a wide-screen TV to the DVD player.

4:3 LETTER BOX → when you connect a normal TV to the DVD player. Displays a wide picture with bands displayed on the upper and lower portions of the TV screen.

4:3 PAN SCAN → when you connect a normal TV to the DVD player. Displays the wide picture on the whole TV screen with a portion automatically cut off.

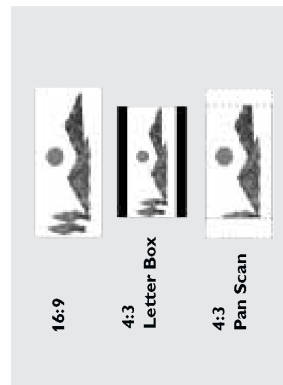

Note:

- Pan Scan is subject to availability on the disc.

– Black level shift (NTSC output only)

Select **ON** for adapting the colour dynamics to obtain richer contrasts.



– Video shift

Use this setting to personalize the position of the picture on your TV by scrolling it to the left or right.



– Monitor type selection

Allows you to select the type of display device that is connected to the DVD Video player.

For each device, a set of predefined picture settings (eg. Rich-Natural-Soft+Animation) is available. Or choose 'Personal' that allows you to fine tune the brightness, saturation and contrast according to your preference.



Notes:

- You can select one of the following display devices: eg. TV, Plasma TV, Video Projector and Projection TV.

Preparation

English

– Smart Picture

You can select one of five predefined sets of colour settings and one set (Personal) which you can define yourself.

You can also press **SMART PICTURE** key (front panel) to access the smart picture in the menubar.

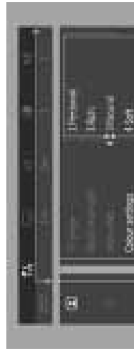

- When **Personal** is selected it allows you to fine-tune saturation, brightness and contrast. Use **▲** or **▼** keys to adjust the values of these parameters.

– TV System (NTSC/PAL Conversion)

Allows you to select between PAL, NTSC and AUTO mode depending on your TV.

The conversions supported are as follows:

Disc Type	Format	Output format		
		Digital mode	PAL	AUTO
DVD	NTSC	NTSC	PAL	NTSC
	PAL	Not supported	PAL	PAL
VCD	NTSC	NTSC	PAL	NTSC
	PAL	NTSC	PAL	PAL

- 1 In the Personal Preferences Menu, select **TV System**.
- 2 Press **▲** or **▼** to select PAL, NTSC or AUTO.



Notes:

- If you have a PAL only TV, ensure that your PAL/NTSC setting is PAL.
- AUTO can only be selected when using a TV that has both the NTSC and PAL systems.
- This setting is applicable for CVBS output on cinch and SCART only.
- Slight picture distortions may occur due to this conversion. This is normal. Thus, the AUTO format is most suitable for the best picture quality.

Sound

– Digital output

- Digital output selection enables you to specify the type of digital output suitable for your receiver.
- Select **ALL** (default setting), if you had connected your DIGITAL AUDIO OUT to a multichannel decoder receiver.
- Select **PCM** only if your receiver is not capable of decoding multichannel audio.
- Select **OFF** to deactivate the DIGITAL AUDIO OUT.

Preparation

– Analogue output

Select Stereo, Dolby Surround compatible or 3D Sound (Insurround) output to match your system's playback capability.



– Night Mode

When set to ON, the dynamics of your sound output are optimised. High volume outputs are softened, enabling you to watch your favourite action movie without disturbing others.

– Subwoofer cut-off

The frequency of the subwoofer output can be set to HIGH (200Hz) or LOW (100Hz) to match your system's playback sound quality.

– PCM Output

Allows to select PCM digital output between 48kHz and 96kHz. When 48kHz has been selected, 96kHz PCM data (if available on disc) stream will be converted to 48kHz. Some 96kHz DVD are copy protected. If your PCM output selection is 96kHz, the digital output will be muted to comply with the standards. In such cases, select 48kHz to enable digital output.

– Karaoke vocal

Put this setting to ON only when a multi-channel karaoke DVD is being played. The karaoke channels on the disc will then be mixed into a normal stereo sound.

Language

Selecting disc languages:

Menu/Audio/Subtitle language

- This is to select the audio language, subtitle language and the language used in TV screen menus or DVD menus which will always be used for every disc to be played back.
- If the language selected is not available on the disc, the default language designated by each disc will be selected.

Preparation

Features

– Access Control

Access Control contains the following features: Child Lock - When Child Lock is set to ON, a 4-digit code needs to be entered in order to playback discs.

Parental control - Allows the conditional presentation of DVDs containing Parental Control information (see 'Access Control' section).

– Status Window

Displays the current status of the player and appears with the menu bar. When disc playback is stopped, it is displayed with the 'Temporary Feedback Field' in the default screen. See 'On-Screen Display' information. Factory setting is ON. Select OFF to suppress display of the Status Window.



– Help text

When set to ON, help text describes the icons selected. Select OFF if you no longer require the help text.

– Low Power Standby

If this is set to ON, the player will go in low-power standby when the standby button is pressed (front panel or remote control).

– Beeper

The beeper can be set to ON or OFF.

– PBC (Playback Control - for VCD)

The Playback Control can be set to ON or OFF (see section "Special VCD & SVCD Features" for details).

– Smart Power OFF

Puts the set to standby after a predefined time. This can be set to ENABLE or DISABLE.

– Bit Rate Indicator

Press the **DISPLAY** key to activate the bit rate indicator. When activated, the bit rate for video and audio, as well as the total bit rate is displayed. This is only applicable during playback of DVD and SVCD discs.

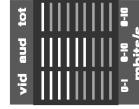

Operation

English

Basic Playback

- 1 Press **STANDBY ON** on the front panel.
- 2 Press **OPEN/CLOSE** \blacktriangle on the front panel to open disc loading tray.
- 3 Place the chosen disc in the tray, with the label facing up.
- 4 Press **OPEN/CLOSE** \blacktriangle again to close the tray. \rightarrow **RETURN** appears in the status window and on the player display, and playback starts automatically.

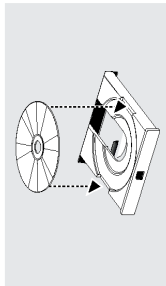

Notes:

- DVDs may have a region code. Your player will not play discs that have a region code different from the region code of your player.
- If Child Lock is set to ON and the disc inserted is not authorised, the 4-digit code must be entered and/or the disc must be authorised (see Access Control).

Playing a DVD-Video

- DVD video discs may have one or more **TITLES**, and each **TITLE** may have one or more **CHAPTERS**.
- Playback stops at the end of each **TITLE**.

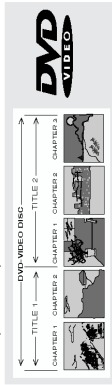

Playing a title

- 1 Insert a disc and close the tray, playback starts automatically.
 - \rightarrow The TV screen's and DVD player's display shows the type of disc loaded, disc's information and playing time.
- 2 When the Disc Menu appear on the TV screen, use \blacktriangleright \blacktriangleleft keys or numerical keys on the remote control to select an option and continue playback.
- 3 If the titles are numbered, press the numerical keys or use the \blacktriangleright \blacktriangleleft keys to select desired title in the menu bar.
- 4 To stop playback, press **STOP**.

Smart Resume

- In stop mode and when a disc has not been ejected,
 - \rightarrow Pressing **PLAY** will automatically resume playback from the point where the playback was last stopped.
- **To deactivate auto resume,**
 - \rightarrow Press **STOP** to stop playback.
 - \rightarrow The help line text appears "Press Stop again to start from beginning" for 5 seconds.
- Press **STOP** again or unload the discs, the auto resume is cancelled.
- **To activate auto resume,**
 - Reload the disc and press **PLAY**
 - \rightarrow Playback starts from the beginning of the title.
- When resume icon \blacktriangleright appears on the screen,
 - press **PLAY** again.
 - \rightarrow Playback will resume from the point where the playback was last stopped.

Note:

- Resume feature is also applicable to VCDs and SVCDs.

Operation

English

Playing a disc

- 1 Insert a disc and close the tray, playback starts automatically.
 - \rightarrow The TV screen will display the number of tracks for selection and current playing status. Playback will stop at the end of the disc.
- 2 To stop playback, press **STOP**.

Special DVD Features

DVDs may contain menus to navigate the disc and access special features. Press the appropriate numerical key or use the \blacktriangleright \blacktriangleleft keys to highlight your selection in the DVD menu and press **OK** to confirm.

Title/Disc menu

- 1 Press **DISC MENU**
 - \rightarrow If the current title has a menu, the menu will appear on the screen. Otherwise, the disc menu will be displayed.
- 2 If disc menu is available on the disc, audio language, subtitle options, chapters for the title and other options will appear for selection.
- 3 To remove the title/disc menu, press **DISC MENU** again.

Camera Angle

- Some discs contain scenes which have been shot simultaneously from various angles. This DVD player allows you to select the desired camera angle.
- When the DVD player encounters a scene shot in multiple angles, it will give an indication on the "Temporary Feedback Field".
 - \rightarrow The angle icon remains displayed until multiple angles are no longer available.
 - Use the \blacktriangleright \blacktriangleleft to select the required angle.
 - \rightarrow Playback changes to the selected angle.
 - You can also select \blacktriangleright (**ANGLE**) in the menu bar or press the **ANGLE** button on the remote control directly.
- ### Changing the audio language
- 1 Select \blacktriangleright (**AUDIO**) in the menu bar or press the **AUDIO** button on the remote control directly.
 - 2 Press **AUDIO** or \blacktriangleright repeatedly to select the different languages.

Playing a Video CD

- Video CDs may have one or more **TRACKS**, and **TRACKS** may have one or more **INDEXES**.
- To make easy and convenient access, you can move between **TRACKS** and **INDEXES**.
- Some Video CDs have Play Back Control (PBC), which is a predefined playback sequence stored on the disc (see Playback Control section).

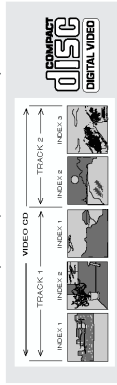

Playing a disc

- 1 Insert the disc and close the tray, playback starts automatically.
 - \rightarrow The number of tracks and the total playing time of the disc will appear on the TV screen and DVD player's display.
- 2 Press **PLAY**.
 - \rightarrow The current track number and its elapsed playing time will be displayed.
 - Playback will stop at the end of the disc.
- 3 To stop playback, press **STOP**.
- 4 Disc Resume feature is also applicable for VCDs and SVCDs (see "Smart Resume" section).

Playing an Audio CD

- Audio CDs contain only **TRACKS**.
- They can be played on your DVD player with the audio output connected to a stereo system or to your TV.
- If CD-text is available on the disc, it will be display on both the TV screen and player's front display.
- Select tracks using the menu bar on the TV screen or by pressing the numerical keys directly.
- Your DVD player also allows you to compile Favourite Track Selection (FIS) programmes for your discs by selecting or excluding tracks of your choice (see FIS Programme - Audio CDs).

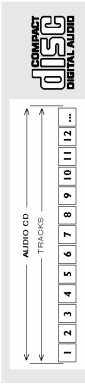

Operation

Subtitles

- 1 Select **(SUBTITLE)** in the menu bar or press the **SUBTITLE** button on the remote control directly.
- 2 Press **SUBTITLE** or **▲▼** repeatedly to select the different subtitles.

Special VCD & SVCD Features

Playback Control (PBC)

- 1 Load a Video CD with PBC and press **PLAY**.
- 2 Go through the menu with the keys indicated on the TV screen until your chosen passage starts to playback. If a **PBC** menu consists of a list of tracks, you can select a track directly.
- 3 Enter your choice with the numerical keys (0-9).
- 4 Press **RETURN** to go back to the previous menu, if applicable on the menu.
- 5 You may also select **PBC OFF** under Personal Preferences.
 - When set to OFF, PBC menus are not activated for further playback.

Special CD & MP3 Features

CD text and MP3 text

- 1 Some CD or MP3-CD discs may contain text information (eg. track name, album name, artist name etc.) which will appear on the DVD player and TV screen during playback.
- 2 By default, CD text display is set to ON.
- 3 To switch off the CD text display, press **CD TEXT (DISPLAY)** on the remote control during playback.
- 4 Press **CD TEXT (DISPLAY)** on the remote control again to switch on the text display mode.



General Features

- Note:
- Unless stated, all operations described are based on remote control use. Some operations can be carried out using the menu bar on the TV screen.

Moving to another title/chapter

DVD VCD

When a disc has more than one title/track or chapter, you can move to another title/chapter as follows:

- 1 Press **SYSTEM MENU**, then select **T** or **C** in the menu bar.
- 2 Press **▲▼** or numerical keys to select a title/chapter.
 - **CD**
- 3 Press **▶▶** or **◀◀** briefly during playback to go to the next track or to return to the beginning of the current track respectively.
- 4 Press **◀◀◀** or **▶▶▶** twice briefly to step back to the previous track.
- 5 To go directly to any track, enter the track number using the numerical keys (0-9).

Note:

- Long press of the **▶▶▶** or **◀◀◀** keys will switch the DVD player on **BACKWARD** or **FORWARD** search (see **SEARCH** section).

Search

DVD VCD

- 1 Select **(FAST MOTION)** in the menu bar and press **▼**.
- 2 Use the **◀▶** keys to select the required speed: -32, -8 or -4 (backward), or +4, +8, +32 (forward).
- 3 Select 1 to play the disc at normal speed again.
- 4 To exit **FAST MOTION** mode, press **PLAY** or **▲**.

CD

- To search forward or backward through different speeds, you can also hold down **▶▶▶** or **◀◀◀** for more than two seconds.

20

Operation

Repeat

DVD

Repeat chapter/title/disc

- To repeat the current chapter, press **REPEAT**.
- **REPEAT CHP** appears on the front display.
- To repeat the current title, press **REPEAT** a second time.
- **REPEAT TTL** appears on the front display.
- To repeat the entire disc, press **REPEAT** a third time.
- **REPEAT DISC** appears on the front display.
- To exit Repeat mode, press **REPEAT** a fourth time.

VCD CD

Repeat track/disc

- To repeat the current track, press **REPEAT**.
- **REPEAT TRK** appears on the front display.
- To repeat the entire disc, press **REPEAT** a second time.
- **REPEAT DISC** appears on the front display.
- To exit Repeat mode, press **REPEAT** a third time.

Repeat A-B DVD VCD CD

- **DVD-Video Discs: repeat a sequence in a title**
 - Video and Audio CDs: repeat a sequence in a track
- 1 Press **REPEAT A-B** at your chosen starting point.
- 2 Press **REPEAT A-B** again at your chosen end point.
 - **REPEAT A-B** appears briefly on the front display, and the repeat sequence begins.
- 3 To exit the sequence, press **REPEAT A-B**.

Slow Motion DVD VCD

- 1 Select **(SLOW MOTION)** in the menu bar and press **▼**.
 - Playback will pause.
- 2 Use the cursor keys **◀▶** to select the required speed: -1, -1/2, -1/4 or -1/8 (backward), or +1/8, +1/4, +1/2 or +1 (forward).
- 3 Select 1 to play the disc at normal speed again.
- 4 If **III** is pressed, the speed will be set to zero (**PAUSE**).
- 5 To exit slow motion mode, press **PLAY**.

Still Picture and Frame-by-frame playback DVD VCD

- 1 Select **(STEP)** in the menu bar and press **▼**.
 - Playback will pause.
- 2 Use the cursor keys **◀▶** to select the previous or next picture frame.
- 3 To exit step by step playback, press **PLAY** or **▲**.

Note:

- You can also activate **frame-by-frame** playback by pressing the **PAUSE** key repeatedly on the remote control.

Scan DVD VCD CD

Scanning plays the first 10 seconds of each chapter/track on the disc.

Press SCAN

- 1 To continue playback at your chosen chapter/track, press **SCAN** again or press **PLAY**.

Operation

English

Shuffle



This shuffles the playing order of chapters within a title, if the title has more than one chapter:

- 1 Press **SHUFFLE** during playback.
- **SHUFFLE** appears on the screen for about two seconds.
- 2 To return to normal playback, press **SHUFFLE** again.



This shuffles the playing order of tracks within a disc, if the disc has more than one track:

- 1 Press **SHUFFLE** during playback.
- **SHUFFLE** appears on the screen for about two seconds.
- 2 To return to normal playback, press **SHUFFLE** again.

Time search

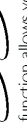

The Time Search function allows you to start playing at any chosen time on the disc.

- 1 Select **(TIME SEARCH)** in the menu bar and press **Y**.
- Playback will pause.
- The elapsed playing time is displayed in a time edit box.
- 2 Enter hours, minutes and seconds from left to right in the time edit box using remote control numerical key pad.
- Each time an item has been entered, the next item will be highlighted.
- 3 Press **OK** to confirm the selected time.
- The time edit box will disappear and playback starts from the selected time position on the disc.



- 4 Press **SYSTEM MENU** to remove the menu bar.

Zoom



The Zoom function allows you to enlarge the video image and to pan through the enlarged image.

- 1 Select **(ZOOM)**.
- 2 Press **▲/▼** to activate the **ZOOM** function and select the required zoom factor: 1.33 or 2 or 4.
- Playback will continue.
- The selected zoom factor and 'Press **OK** to pan' appears below the menu bar.
- The zoomed picture will appear on the TV screen.
- 3 Press **OK** to confirm the selection.
- The panning icon appears on the screen.
- 4 Use the **◀▶▶▶▶** keys to pan across the screen. When **OK** is pressed only the panned picture will be shown on the screen.
- 5 To exit **ZOOM** mode, select zoom factor to "Off" (zoom factor 1) in the menu bar.



FTS Video/Audio Programme

- Favourite Track Selection (FTS) list contains up to 20 items (titles, chapters).
- The most recent programme list will be placed on top of the existing list.



Storing a Programme

- 1 While playback is stopped, select **VIDEO FTS** in the menu bar.
- 2 Press **▼** to open the menu bar.
- The **VIDEO FTS** menu appears.
- 3 Press **▶** or **◀** or **FTS** (on the remote control) to select **ON**.

Operation

English

Storing titles/tracks



- 1 Press **▼** to select **TITLES/TRACKS**.
- 2 Use **▶** and **◀** to select the require title/tracks.
- 3 Press **OK** to store the entire selected title/tracks.
- The title number will be added to the list of selections.

Storing chapters/indexes

- 1 Press **▼** on the selected chapter/indexes number: → The chapter/indexes number will be highlighted.
- 2 Use **▶** and **◀** to select the required chapter number.
- 3 Press **OK** to confirm the selection.
- The selected chapter/indexes confirmation will be added to the list of selections.
- 4 Press **SYSTEM MENU** to exit the **VIDEO FTS** menu.

Erasing a selection in a Programme

- 1 While playback is stopped, select **VIDEO FTS** in the menu bar.
- 2 Use **▼** to select **PROGRAM**.
- 3 Use **▶** and **◀** to select the required number.
- 4 Press **OK** to erase the selection.
- 5 Press **SYSTEM MENU** to exit.

Erasing all selections

- 1 While playback is stopped, select **VIDEO FTS** in the menu bar.
- 2 Use **▼** to select **CLEAR ALL** and press **OK**.
- All selections will be erased.
- 3 Press **SYSTEM MENU** to exit.



Storing a Programme

- 1 Load a disc and stop playback.
- 2 Press **▼** to go to the list of available tracks.
- 3 Use **▶** and **◀** to select the required tracks or directly using remote control numeric key.
- 4 Press **OK** to store the selected tracks.
- The track number will be added to the list of selections.

Switching a Programme ON/OFF

- 1 Use **▲▼** to move and select desired tracks.
- 2 Press **▶** or **◀** to select either **ON** or **OFF**.

Erasing a track in a Programme

- 1 Use **▼** to go to the programmed tracks.
- 2 Use **▶** and **◀** to select the required number.
- 3 Press **OK** to erase the selection.
- 4 Press **SYSTEM MENU** to exit.

Erasing all selections

- Use **▼** to select **CLEAR ALL** and press **OK**.
- All selections will be erased.



English

Access Control

- Each time a 'child safe' disc is played, it will be placed on top of the list. When the list is full, the last disc in the list will be replaced when a new disc is added.
- Double-sided DVDs and multi-volume VCDs may have a different ID for each side. In order to make the disc 'child safe', each side has to be authorised.

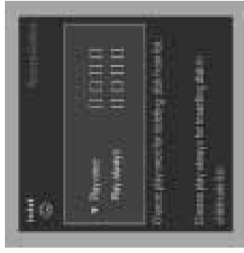

Child Lock DVD VCD

- When disc playback is stopped, select **ACCESS CONTROL** in the Personal Preferences menu using the **▲▼** keys.
- Enter a 4-digit code of your own choice twice.
- Move to **'CHILD LOCK'** using the **▲▼** keys.
- Move to **1** using the **▶** keys.
- Select **1** using the **▲▼** keys.
- Press **OK** or **◀** to confirm, then press **◀** again to exit the Personal Preferences menu.
- Now unauthorised discs will not be played unless the 4-digit code is entered.
- Select **1** to deactivate the **CHILD LOCK**.

- Notes:**
- Confirmation of the 4-digit code is necessary when:
 - The code is entered for the very first time (see above).
 - The code is changed or cancelled (see 'Changing the 4-digit code').

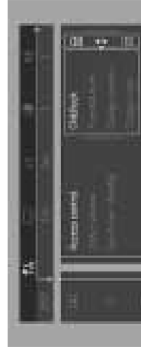

Deauthorising discs

- Insert the disc.
- Press **▶** while **☺** is visible.
- The **☺** will appear and the disc is now deauthorised.

Parental Control DVD

Movies on DVDs may contain scenes not suitable for children. Therefore, discs may contain 'Parental Control' information which applies to the complete disc or to certain scenes on the disc. These scenes are rated from 1 to 8, and alternative, more suitable scenes are available on the disc. Ratings are country dependent. The 'Parental Control' feature allows you to prevent discs from being played by your children or to have certain discs played with alternative scenes.



Authorising discs

- Insert the disc.
- You will be asked to enter your secret code for 'Play Once' or 'Play Always'.
- If 'Play Once' disc can be played when in the player and the player is ON.
- If 'Play Always' disc will become authorised and can always be played, even if the Child Lock is set to ON.

Notes:

- The player memory can maintain 120 authorised ('Child safe') disc titles. A disc will be placed in the list when 'Play Always' is selected.

Operation

MP3 Disc Features

Support following MP3-CD formats (ISO9660 format):

- Max. 30 characters
- Max. nested directory is 8 levels
- The max. ALB number is 32
- Supported VBR bit-rate
- Supported sampling frequencies for MP3 disc are: 32 kHz, 44.1 kHz, 48 kHz
- Supported Bit-rates of MP3 disc are: 32, 64, 96, 128, 192, 256 (kbps)

Following formats can't be supported

- The files like *.WMA, *.AAC, *.DLE, *.M3U, *.PLS
- Chinese filenames
- The non-session closed discs
- The discs recorded under UDF format

Downloading MP3 files from the Internet or copying songs from your own legal discs is a delicate process.

Sound Format	Bit Rate	Approximate File Size	Approximate Total File Size	Comment
MP3	32 kbps	40 s	1.3 MB	Sound quality significantly degraded
MP3	64 kbps	20 s	0.6 MB	Not recommended
MP3	96 kbps	15 s	0.5 MB	Balanced sound quality
MP3	128 kbps	10 s	0.4 MB	Compression ratio
MP3	192 kbps	7 s	0.3 MB	Compression ratio low
MP3	256 kbps	5 s	0.2 MB	Compression ratio low
MP3	320 kbps	4 s	0.1 MB	Compression ratio low

You may experience an occasional "skip" while listening to your MP3 files. This is normal.

Additional note for MP3 disc Playback:

- In compliance with the SDMI, digital-out is muted while playing MP3 discs.
- Due to the recording nature of Digital Audio MP3 (DAM), only Digital Audio music will play.
- The disc reading time may exceed 10 seconds due to the large number of songs compiled onto one disc.
- For multi-session discs, only the first session will be available.

English

Album/Title

This feature allows you to view and select the next or previous MP3 disc Album/Title.

- Press **▲▼** to scroll through the previous or next Album.
- Press **◀▶** to scroll through the previous or next Track.
- You can also select the desired album/track number directly using the numeric keys on the remote control.

Note:

- In **STOP mode: numbers are used for ALBUM selection.**
- In **PLAY mode: numbers are used for TRACK selection.**



- Only the following functions are possible for MP3 discs:
 - STOP / PLAY / PAUSE
 - SKIP NEXT / PREVIOUS
 - REPEAT (TRACK / ALBUM / DISC)

MP3 Discs - Album/Track/Disc

- To repeat a track, press REPEAT.
- REPEAT TRK appears on the player display.
- To repeat an album, press REPEAT a second time.
- REPEAT ALBM appears on the player display.
- To repeat the entire disc, press REPEAT a third time.
- REPEAT DISC appears on the player display.
- To exit REPEAT mode, press REPEAT a fourth time.
- REPEAT OFF appears on the player display.

Access Control

English

Activating/Deactivating Parental Control

- 1 When disc playback is stopped, select **ACCESS CONTROL** in the Personal Preferences menu using the **▲▼** keys.
- 2 Enter your 4-digit code. If necessary, enter the code a second time.
- 3 Move to **Parental Control** using the **▲▼** keys.
- 4 Move to value adjustment (1-8) using the **►** key.
- 5 Then use the **▲▼** keys or the numerical keys on the remote control to select a rating from 1 to 8 for the disc inserted.

Rating 0 (displayed as “-”):
Parental Control is not activated. The Disc will be played in full.

Ratings 1 to 8:

The disc contains scenes not suitable for children. If you set a rating for the player, all scenes with the same rating or lower will be played. Higher rated scenes will not be played unless an alternative which has the same rating or lower is available on the disc. If no suitable alternative is found, playback will stop and the 4-digit code has to be entered.

- 6 Press **OK** or **◀** to confirm, then press **◀** again to exit the Personal Preferences menu.



Country

- 1 When disc playback is stopped, select **ACCESS CONTROL** in the Personal Preferences menu using the **▲▼** keys.
- 2 Enter the 4-digit code.
- 3 Move to **CHANGE COUNTRY** using the **▼** key.
- 4 Press the **►** key.
- 5 Select a country using **▲▼**.
- 6 Press **OK** or **◀** to confirm, then press **◀** again to exit the menu.

PLAYBACK SYSTEM

DVD Video
Video CD & SVCD
CD (CD-Recordable and CD-Rewritable)
MP3 CD

TV STANDARD (PAL/50Hz) (NTSC/60Hz)

Number of lines 625
Multistandard (PAL/NTSC)

VIDEO PERFORMANCE

Video output 1Vpp into 75 ohm
RGB (SCART) output 0.7Vpp into 75 ohm
Black Level Shift On/Off
Video Shift Left/Right

AUDIO FORMAT

Digital MPEG Compressed
Dolby Digital Digital
PCM 16, 20, 24 bits
MPEG MP3 16, 44.1, 48, 96 kHz
Analogue Stereo Sound MPEG Audio L3
Dolby Surround-compatible downmix from Dolby Digital multi-channel sound

3D Sound for virtual 5.1 channel sound on 2 speakers

Specifications

AUDIO PERFORMANCE

D/A Converter 24 bits
DVD 4 Hz - 44 kHz
DVD/SVCD 16, 96 kHz
4 Hz - 22 kHz
4 Hz - 20 kHz
SVCD/CD 16, 44.1 kHz
Signal-Noise (1kHz) > 110 dB
Dynamic Range (1kHz) > 100 dB
Crosstalk (1kHz) > 105 dB
Distortion and Noise (1kHz) > 90 dB
MPEG MP3 MPEG Audio L3

CONNECTIONS

SCART 2x Euroconnector
S-Video Output Mini DIN, 4 pins
Video Output Cinch (yellow)
Audio L+R output 2x Cinch (white/red)
Audio Subwoofer Cinch (black)
Digital Output 1 coaxial, 1 optical
IEC958 for CDDA / LPCM IEC1937 for MPEG1/2, Dolby Digital

CABINET

Dimensions (w x h x d) 435 x 77.5 x 303.5 mm
Weight Approximately 2.8 kg

* typical playing time for movie with 2 spoken languages and 3 subtitle languages

Specifications subject to change without prior notice

Maintenance

Cleaning the Cabinet

- Use a soft cloth slightly moistened with a mild detergent solution. Do not use a solution containing alcohol, spirits, ammonia or abrasives.

Cleaning Discs

- When a disc becomes dirty, clean it with a cleaning cloth. Wipe the disc from the centre out. Do not wipe in a circular motion.
- Do not use solvents such as benzine, thinner, commercially available cleaners, or antistatic spray intended for analogue records.

Cleaning the disc lens

- After prolonged use, dirt or dust may accumulate at the disc lens. To ensure good playback quality, clean the disc lens with Philips CD Lens Cleaner or any commercially available cleaner. Follow the instructions supplied with the cleaner.

Troubleshooting

WARNING

Under no circumstances should you try to repair the system yourself, as this will invalidate the warranty. Do not open the system as there is a risk of electric shock. If a fault occurs, first check the points listed below before taking the system for repair.

Problem	Solution
No power	<ul style="list-style-type: none"> Check if the AC power cord is properly connected.
No picture	<ul style="list-style-type: none"> Check if the TV is switched on. Check the video connection.
Distorted picture	<ul style="list-style-type: none"> Sometimes a small amount of picture distortion may appear. This is not a malfunction.
Completely distorted picture or black/white picture with DVD or Video CD	<ul style="list-style-type: none"> Make sure the NTSC/PAL setting at the DVD player matches the video signal of your television. (See NTSC/PAL Conversion/Settings)
No sound or distorted sound	<ul style="list-style-type: none"> Adjust the volume. Check that the speakers are connected correctly.
No audio at digital output	<ul style="list-style-type: none"> Check the digital connections. Check the settings menu to make sure the digital output is set to ALL or PCM. Check if the audio format of the selected audio language matches your receiver capabilities.
No sound and picture	<ul style="list-style-type: none"> Check that the SCART cable is connected to the correct device. (See Connecting to a TV)
Picture freezes momentarily during playback	<ul style="list-style-type: none"> Check the disc for fingerprints/scratches and clean with a soft cloth wiping from centre to edge.
Disc can't be played	<ul style="list-style-type: none"> Ensure the disc label is facing up. Check if the disc is defective by trying another disc.
No return to start-up screen when disc is removed	<ul style="list-style-type: none"> Reset the unit by switching the player off, then on again.
The player does not respond to the remote control	<ul style="list-style-type: none"> Aim the remote control directly at the sensor on the front of the player. Reduce the distance to the player. Replace the batteries in the remote control. Re-insert the batteries with their polarities (+/- signs) as indicated.
Buttons do not work or player stops responding	<ul style="list-style-type: none"> To completely reset the player, unplug the AC cord from the AC outlet for 5-10 seconds.
Player does not respond to some operating commands during playback.	<ul style="list-style-type: none"> Operations may not be permitted by the disc. Refer to the instructions of the disc.
DVD Video player cannot read CDs/DVDs	<ul style="list-style-type: none"> Use a commonly available cleaning CD/DVD to clean the lens before sending the DVD player for repair.

If you are unable to remedy a problem by following these hints, consult your dealer or service centre.

28

For DVD723 models only

Functional Overview

Front and Rear Panels

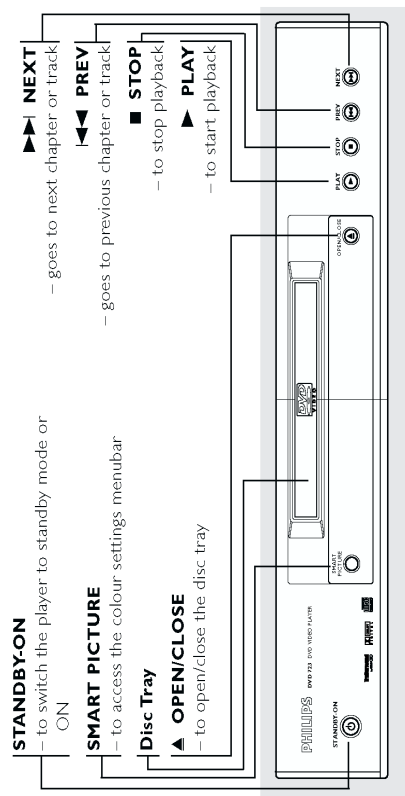

Caution: Do not touch the inner pins of the jacks on the rear panel. Electrostatic discharge may cause permanent damage to the unit.

7

4. Mechanical- and Dismantling Instructions

Dismantling Instructions

DISMANTLING INSTRUCTIONS

See exploded view of DVD723 and DVD743 for item numbers
Item number indicated within [] are only for DVD743.

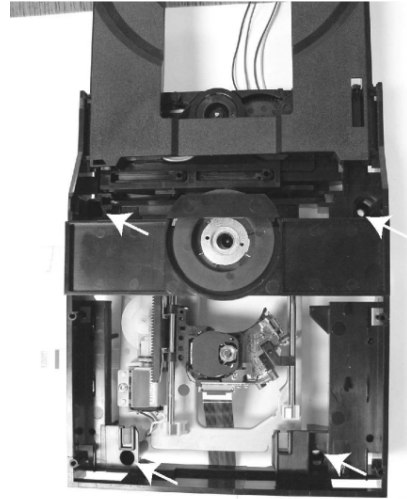
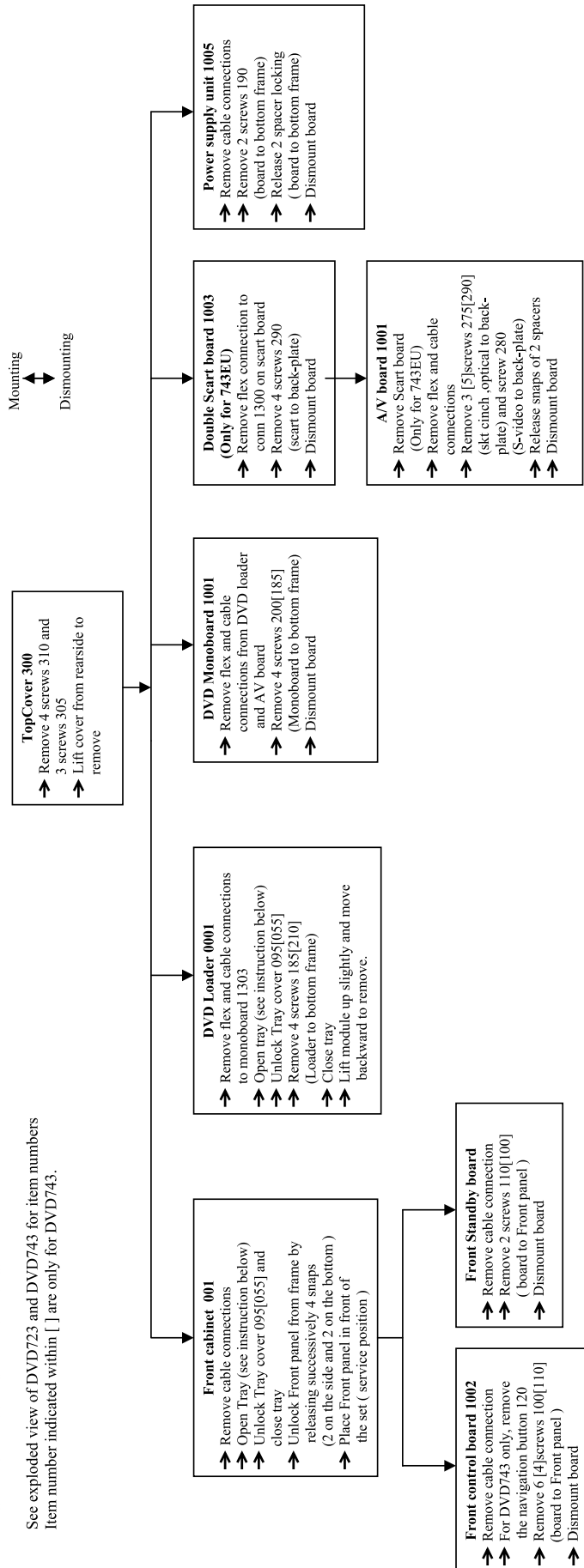

Remove 4 screws to remove loader.

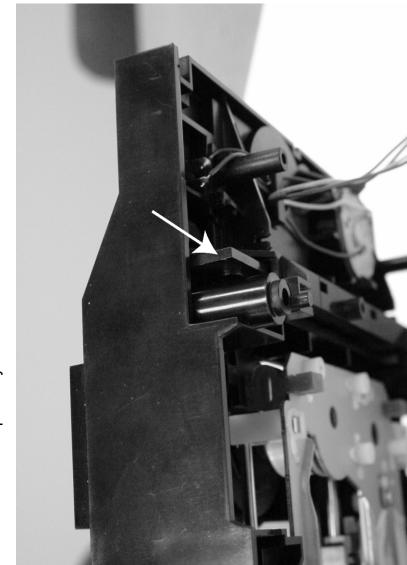

When a disc is loaded, unlock the tray by pushing the slide inwards with a screwdriver and pull tray outwards.



Manually opening of tray

When it is not possible to open the tray with the EJECT button, the tray can manually be opened.

When no disc is loaded, unlock the tray by moving the slide from left to right and pull tray outwards.

Exploded View DVD723/0X1

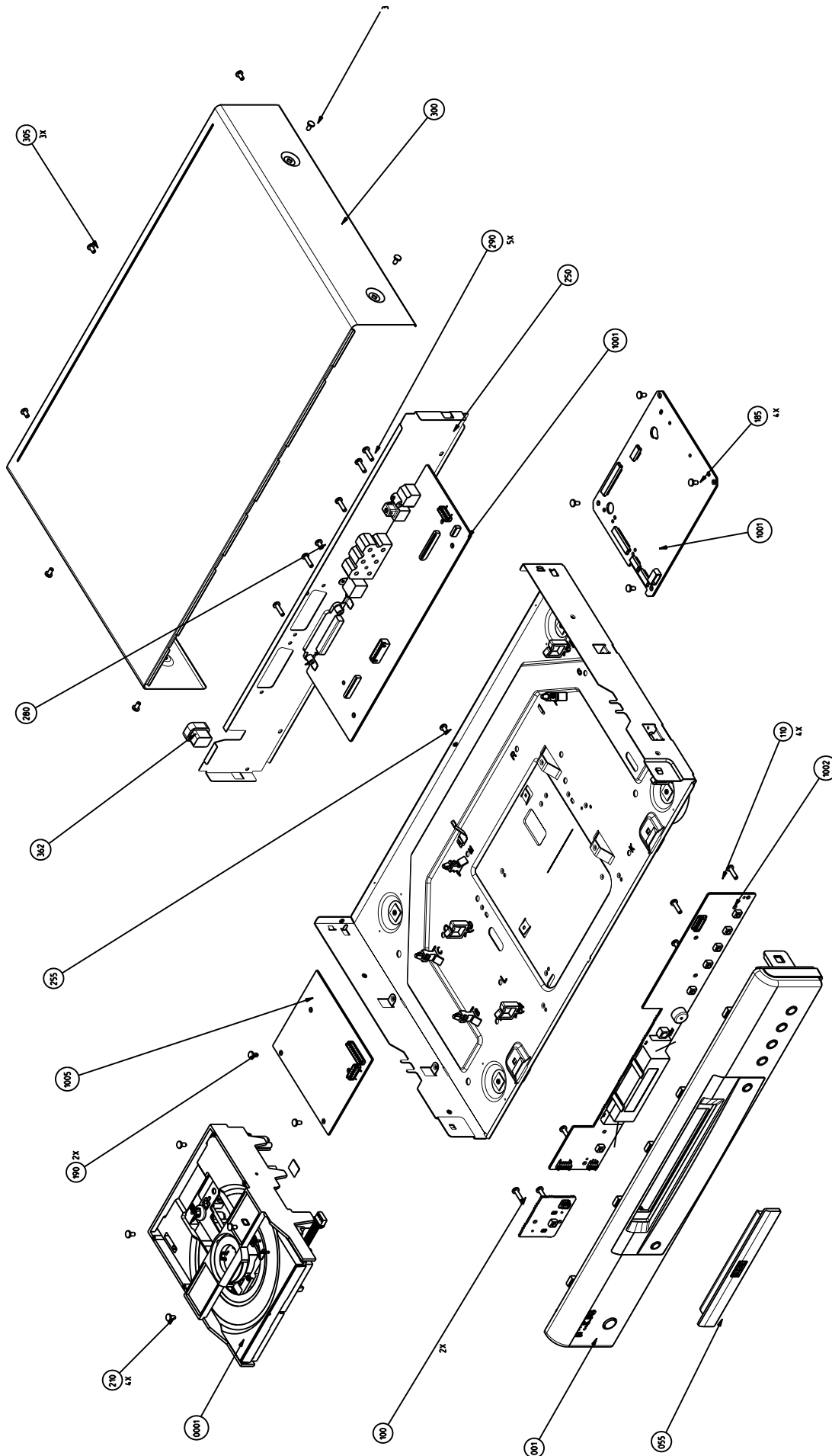

CL 26532039_010.eps
260302

SCALE 1:2

Exploded View DVD743/0X1

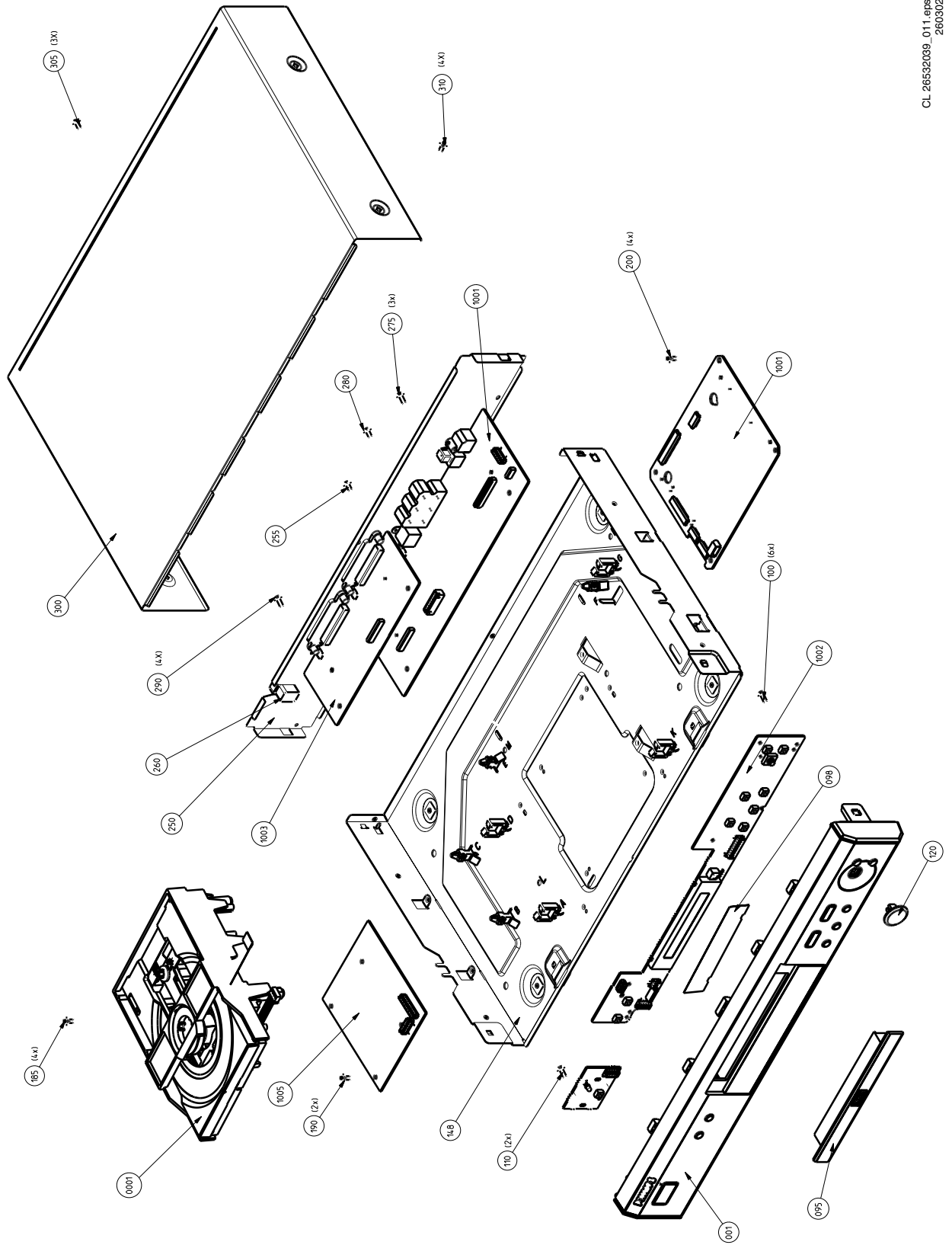

5. Diagnostic Software, Trouble Shooting and Test Instructions

5.1 Dealerscript

5.1.2 Contents of Dealer Script

5.1.1 Purpose of Dealer Script

The dealer script can give a diagnosis on a standalone DVD player, no other equipment is needed to perform a number of hardware tests to check if the DVD player is faulty. The diagnosis is simply a "error" or "pass" message. No indication is given of faulty hardware modules. Only tests within the scope of the diagnostic software will be executed hence only faults within this scope can be detected.

The dealer script executes all diagnostic nuclei that do not need any user interaction and are meaningful on a standalone DVD player.

The nuclei called in the dealer script are the following (the number after each nucleus name corresponds with the number being on the local display when the nucleus is executed during the dealer script):

Nucleus

Display Countdown	Nucleus Number	Nucleus Name	Description
6	6	PapChksFl	Calculate and verify checksum of FLASH memory
5	12	PapI2cDisp	Checks the I2C interface with the slave processor on the display board
4	13	PapS2bEcho	Checks the I2C interface to the basic engine
3	11	PapI2cNvram	Checks the I2C interface with the NVRAM
2	15	PapNvramWrR	Pattern test of all locations in the NVRAM
1	16	CompSdramWrR	Pattern test of all locations in the SDRAM(s)

CL 16532162_026.eps
080102

Figure 5-1

Dealer Script

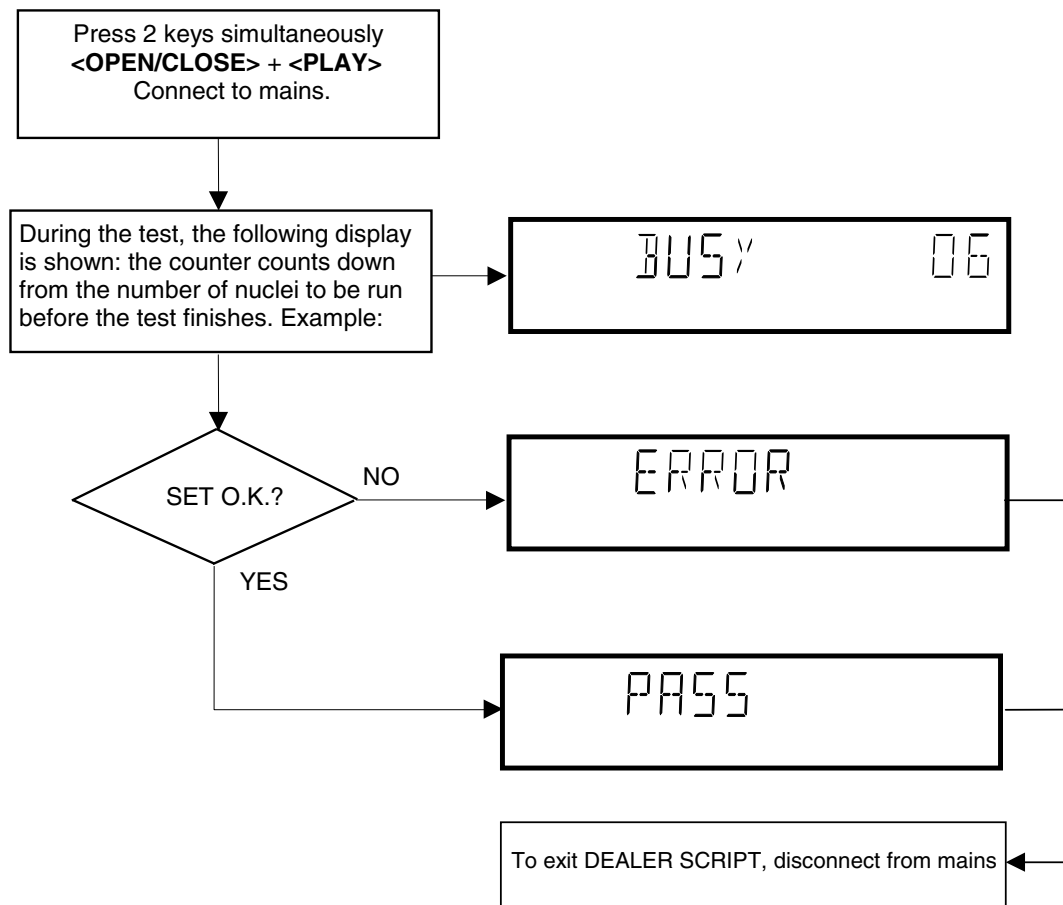

CL 16532162_027.eps
090102

Figure 5-2

5.2 Player Script

Press the OPEN/CLOSE key to proceed to the next test.

5.2.1 Purpose of Player Script

The Player script will give the opportunity to perform a test that will determine which of the DVD player's modules are faulty, to read the error log and error bits and to perform an endurance loop test. To successfully perform the tests, the DVD player must be connected to a TV set to check the output of a number of nuclei. For DVDv2b a multi-channel amplifier, a set of 6 speakers and an external video source are necessary to test. To be able to check results of certain nuclei, the player script expects some interaction of the user (i.e. to approve a test picture or a test sound). Some nuclei (e.g. nuclei that test functionality of the Basic Engine module) require that the DVD player itself is opened, to enable the user to observe moving parts and approve their movement visually. Only tests within the scope of the diagnostic software will be executed hence only faults within this scope can be detected.

5.2.2 Contents of Player Script

The player script contains all nuclei that are useful on a DVD player that is connected to a TV set and help to determine which module of the DVD player is faulty, as well as to read out the contents of the error logs.

5.2.3 Structure of Player Script

The player script consists of a set of nuclei testing the three hardware modules in the DVD player: the Display PWB, the Digital PWB, and the Basic Engine.

Nuclei run by the player test need some user interaction. In the next paragraph this interaction is described. The player test is done in two phases:

1. **Interactive tests:** this part of the player test depends strongly on user interaction and input to determine nucleus results and to progress through the full test. Reading the error log and error bits information can be useful to determine any errors that occurred recently during normal operation of the DVD player.
2. **The loop test:** this part of the player test will loop through the list of nuclei indefinitely, till the player is reset. The list of nuclei is as follows:
 - PapChksFlash
 - PapI2cNvram
 - CompSdramWrR
 - PapS2bEcho
 - PapI2cDisp

At the beginning of the tests, the DSW version number will be indicated on the local display of the DVD.

The display will look like the following:

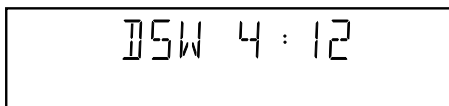

Figure 5-3

Pressing the PLAY key will proceed to the slave S/W version display, which is shown on the local display of the DVD player. The display will look like the following:

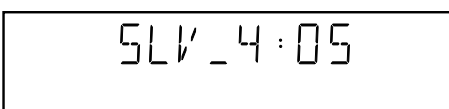

Figure 5-4

5.2.4 Survey

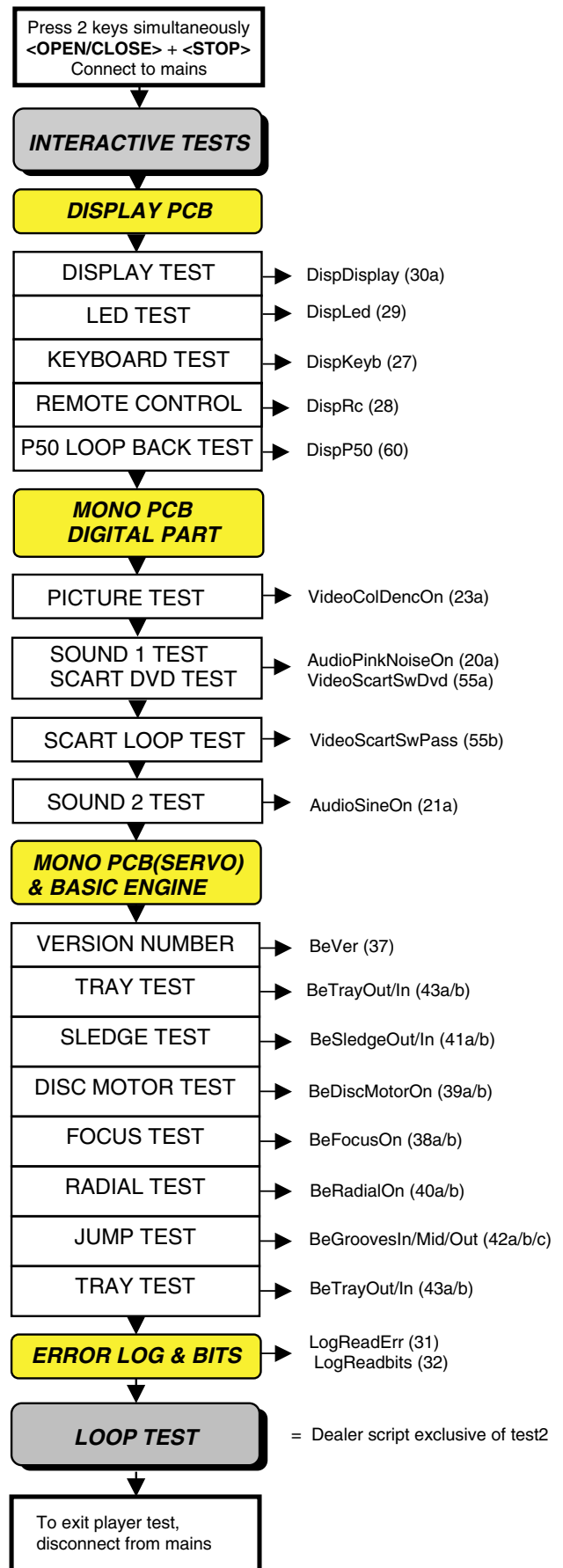

Figure 5-5

5.3 Display PCB

5.3.1 Display Test

The display test is performed by nucleus DispDisplay. By putting a series of test patterns on the local display, the local display is tested. To step through all different patterns, the user must either press OPEN/CLOSE (pattern is ok) or STOP (pattern was incorrect) to proceed to the next pattern. The display of patterns is continued in a cyclic manner, shown in Fig. 5-6, until the user presses PLAY. If the user presses PLAY before all display patterns are tested, the DispDisplay nucleus will return FALSE (display test unsuccessful).

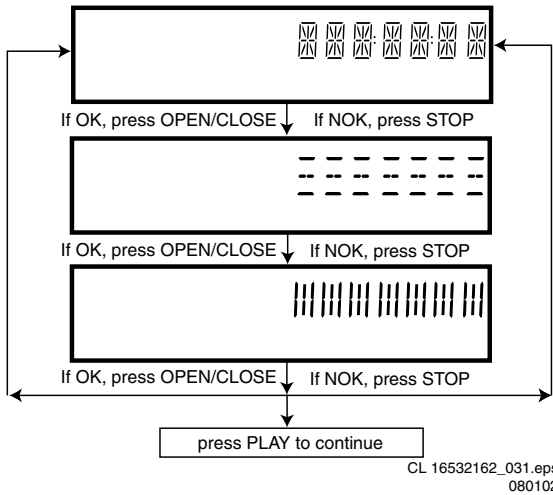

Figure 5-6

5.3.2 LED Test

The LED(s) on the DVD player is (are) tested by nucleus DispLed. The user must check if the LED(s) is (are) lighted; if it is, press OPEN/CLOSE, if it is not, press STOP. By pressing PLAY the script will proceed to the next test. If the user presses PLAY before OPEN/CLOSE or STOP, the DispLed nucleus will return TRUE (LED test successful).

5.3.3 Keyboard Test

The keyboard of the DVD player is tested by nucleus DispKeyb. The user is expected to press all keys on the local keyboard once. The code of the key pressed is shown on the local display (1 hexadecimal digit) immediately followed by a (hexadecimal) number indicating how many times that key has been pressed. Example of the local display during this test:

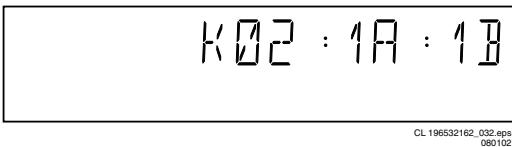

Figure 5-7

The key-codes displayed on the local display will scroll from right to left when the display gets full, the text "K" will remain on display.

KEY ID	KEY
0	PLAY/PAUSE
1	STOP
2	OPEN/CLOSE
3	STANDBY
4	NEXT
5	PREVIOUS
7	SMART PICTURE
8	NAVIGATION -UP
9	NAVIGATION -DOWN
A	NAVIGATION - LEFT
B	NAVIGATION - RIGHT
C	DISC MENU
D	OK
E	SOUND

CL 26532039_027.eps
203020

Figure 5-8

If any keys are detected more than once (due to hardware error), the key-code is displayed twice (or more), with the second digit increased by 1. If the user does not press all keys minimally once (in any order), the DispKeys nucleus will return FALSE and cause an error in the overall result of the player script. The user can leave the keyboard test by pressing the PLAY key on the local display of the DVD player for at least one full second. The result of the keyboard test is shown on local display as follows:

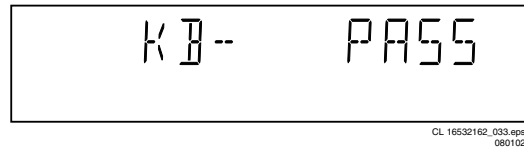

CL 16532162_033.eps
080102

Figure 5-9

Or



CL 16532162_034.eps
080102

Figure 5-10

Pressing PLAY on the local keyboard again will proceed to the next text.

5.3.4 Remote Control Test

The remote control of the DVD player is tested by nucleus DispRc. The user must press any key on the remote control just once. The codes of the key pressed will be shown on the local display in hexadecimal format. Example:

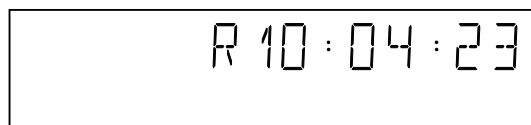

CL 16532162_035.eps
140102

Figure 5-11

In this example 23 is the hexadecimal code of the pressed RC key. The user can leave the remote-control test by pressing PLAY on the local keyboard of the DVD player. The remote control test is successful if a code was received before the user pressed the PLAY key. Pressing the PLAY key, before pressing a key on the remote control, gives an error in the remote control test (note that the remote control test will also fail if a key on the remote control was pressed but no code was received). The remote control test does not check upon the contents of the received code, that is it will not be checked if the received code matches the key pressed. If desired, the user can manually check this code by using a code-table for the remote control key-codes.

RC Key id	Hexadecimal code
STANDBY	0C
1	1
2	2
3	3
4	4
5	5
6	6
7	7
8	8
9	9
0	0
RETURN	83
DISPLAY	EF
DISC MENU	54
SYSTEM MENU	82
CURSOR UP	58
CURSOR DOWN	59
CURSOR LEFT	5A
CURSOR RIGHT	5B
OK	5C
PREVIOUS	21
NEXT	20
STOP	31
PLAY	2C
PAUSE	30
SUBTITLE	4B
ANGLE	85
ZOOM	F7
AUDIO	4E
REPEAT	1D
REPEAT A-B	3B
SHUFFLE	1C
SCAN	2A

CL 16532162_037.eps
080102

Figure 5-12

After pressing PLAY, the result of the remote control test is displayed on the local display of the DVD player as follows:

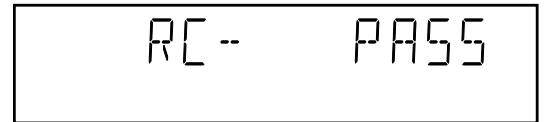

CL 96532065_013.eps
120799

Figure 5-13

Or

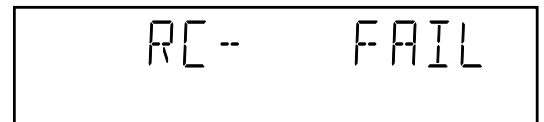

CL 96532065_014.eps
120799

Figure 5-14

Pressing PLAY on the local keyboard again will proceed to the next test.

5.3.5 P50 Loop-Back Test

For the P50 loop-back test, the user must first press a key to decide if the test is to be performed. The display will show the following message:

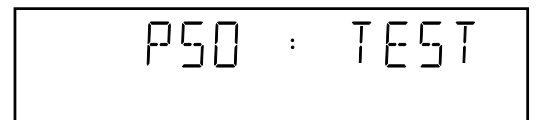

CL 16532007_004.eps
090102

Figure 5-15

If the user presses STOP, the P50 test will be skipped. If the user presses OPEN/CLOSE, the P50 test is performed and the result is displayed as follows:

Test successful:

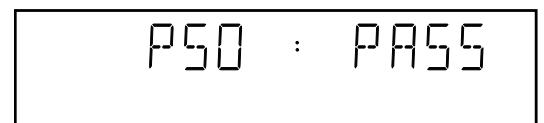

CL 16532007_005.eps
090102

Figure 5-16

Test fails:

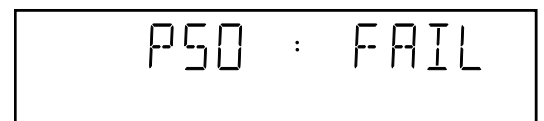

CL 16532007_006.eps
090102

Figure 5-17

Press the PLAY key to continue to the next text

5.4 Mono PCB Digital Part

5.4.1 Picture Test

The picture test is performed by putting a predefined picture (colour bar) on the display (nucleus VideoColDencOn), and asking the user for confirmation.

The display will show the following message:

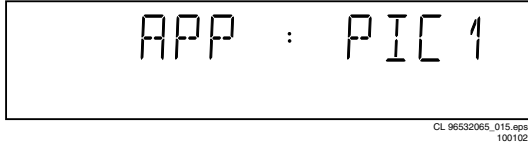

Figure 5-18

By pressing OPEN/CLOSE the user confirms the test, pressing STOP will indicate the picture was invisible or incorrect. Pressing PLAY will proceed to the next test. If the user presses PLAY without pressing OPEN/CLOSE or STOP first, the result of this test will be TRUE (picture ok).

Note: The colour bar must be simultaneously available on the CVBS, YC, and RGB (or YUV) outputs available. On the SCART only the CVBS and RGB signals will be available.

5.4.2 Sound 1 & SCART DVD Test

The first soundtest is performed by starting a pink noise sound that needs confirmation from the user (nucleus AudioPinkNoiseOn).

The display will show the following message:

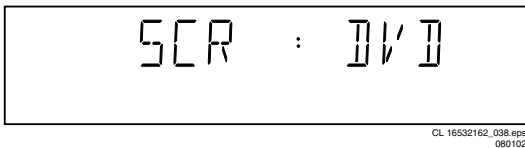

Figure 5-19

On the TV screen a colour bar (generated by nucleus VideoColDencOn) is visible and the internally generated pinknoise is audible.

By pressing the PLAY key, the user confirms the test. Pressing the STOP key will indicate the sound was inaudible or incorrect.

Note: Only for double scart models, SCART loop-through will be simultaneously active during this test. SCART loop-through will be measured with the aid of an external video source.

By pressing the PLAY key, there will be switched over to the external source. This must become now visible on the TV screen (using the SCART).

The local display will show the following message:

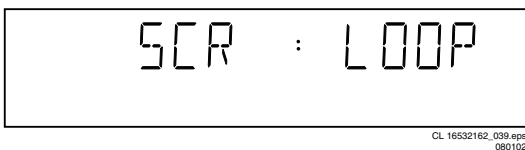

Figure 5-20

The internally generated colour bar is still available on the CVBS and Y/C outputs. And the pinknoise-signal is still available on the cinch audio outputs. By pressing the OPEN/CLOSE button, the internal generated colour bar becomes visual again.

The test can be left by pressing the PLAY key for more than one second.

5.4.3 Sound 2 Test

The second soundtest is performed by producing a sine sound (nucleus AudioSineOn). The signal can be stopped by pressing the STOP key.

The display will show the following message:

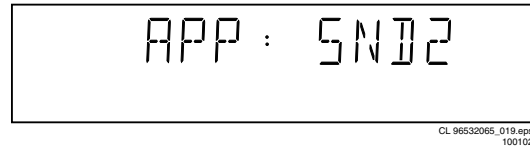

Figure 5-21

After the audio signal has been stopped, by pressing OPEN/CLOSE, the user confirms the test. Pressing STOP will indicate that something went wrong. Pressing PLAY will proceed to the next. If the user presses PLAY without pressing OPEN/CLOSE or STOP first, the result of this test will be TRUE (sound ok).

5.5 Basic Engine

5.5.1 Version Number

In the basic engine tests, the version number of the Basic Engine will be shown first, as the following example:

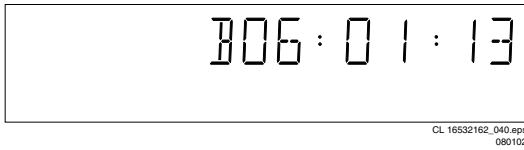

Figure 5-22

By pressing the PLAY key, the Basic Engine tests are started.

5.5.2 Tray Test

First, the tray is tested. The purpose of this test is also to give the user the opportunity to put a disc in the tray of the DVD player. Some tests on the Basic Engine require that a disc (e.g. DVD MPTD test disc) is present in the player. At the end of the Basic Engine tests this tray test will be repeated solely to enable the user to remove the disc in the tray. The local display will look as follows:

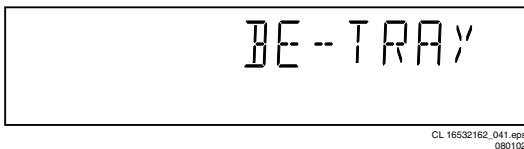

Figure 5-23

By pressing OPEN/CLOSE the user can toggle the position of the tray. Note that this test will not contribute to the test result of the Basic Engine. Pressing PLAY will proceed to the next test. At this point, the tray will be closed automatically by the software if it was open.

5.5.3 Sledge Test (Visual Test)

The second Basic Engine test tests the sledge. The user can move the sledge as many times as desired by using OPEN/CLOSE (nucleus BeSledgeOut) and STOP (nucleus BeSledgeIn). Pressing PLAY on the local keyboard proceeds to the next test. Note that this test will not contribute to the test result of the Basic Engine.

The local display will look as follows during the sledge test:

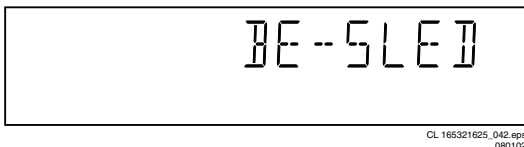

Figure 5-24

5.5.4 Disc Motor Test (Visual Test)

The third Basic Engine test tests the disc motor (nucleus BeDiscMotorOn).

The local display looks as follows:

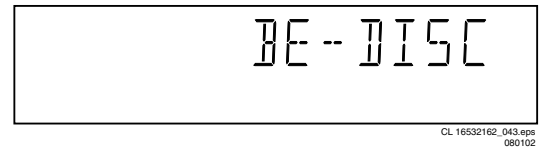

Figure 5-25

By pressing OPEN/CLOSE the user confirms that the disc motor is running. Pressing STOP indicates the disc motor does not work. Pressing PLAY proceeds to the next test, after a reset of the disc motor (nucleus BeDiscMotorOff). If the user presses PLAY before pressing OPEN/CLOSE or STOP, the result of this test will be TRUE (disc motor is running).

5.5.5 Focus Test (Visual Test)

The fourth Basic Engine test tests the focussing. First focussing is turned on by calling nucleus BeFocusOn. The display will look as follows:

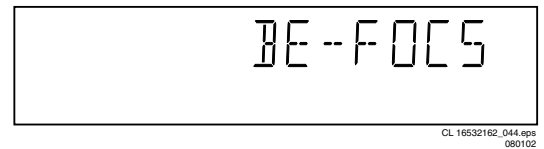

Figure 5-26

By pressing OPEN/CLOSE the user confirms that the focussing was successful. Pressing STOP indicates a focussing failure. Pressing PLAY proceeds to the next test after a reset of the focussing (nucleus BeFocusOff). If PLAY is pressed before OPEN/CLOSE or STOP, the result of this test will be TRUE (focus successful).

5.5.6 Radial Test (Visual & Listening Test)

The fifth Basic Engine test tests the radial functionality (nucleus BeRadialOn).

The local display looks as follows:

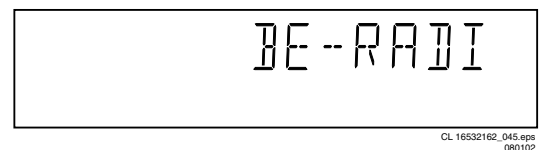

Figure 5-27

By pressing OPEN/CLOSE the user confirms that the radial function works. Pressing STOP indicates the function does not work. Pressing PLAY proceeds to the next test, after a reset of the radial (nucleus BeRadialOff). If the user presses PLAY before pressing OPEN/CLOSE or STOP, the result of this test will be TRUE (radial successful).

5.5.7 Jump Test (Listening Test)

The sixth and last Basic Engine test tests the jumping by calling nuclei BeGroovesIn, BeGroovesMid and BeGroovesOut. During this test, the local display looks as follows:

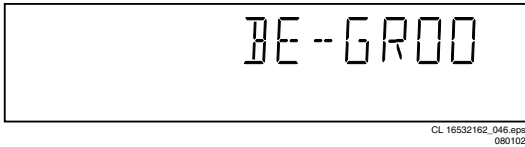

Figure 5-28

The user can switch between the three different types of groove settings by pressing OPEN/CLOSE (forward to next nucleus in the list In-Mid-Out), or STOP (backward in the list In-Mid-Out). This is done in a cyclic manner; note that this test will not contribute to the test result of the Basic Engine. Pressing PLAY proceeds to the next test, after the disc motor has been shut off with a call to nucleus BeDiscMotorOff.

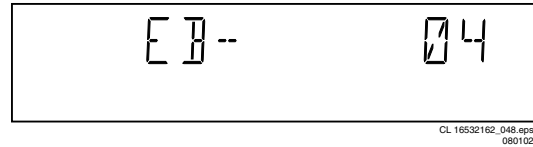

Figure 5-31

Only the identification number (decimal) representing set errorbits will be shown. By pressing OPEN/CLOSE or STOP, the user can move forward or backward (respectively) through the logged errorcodes. If the display only shows "EB-0", no error bits were set. By pressing PLAY the user can continue to the next test.

5.5.8 Tray Test

As a last action for the Basic Engine tests, the tray test is repeated. The local display will look as follows:

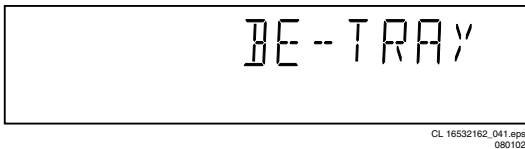

Figure 5-29

This test is meant to give the user the opportunity to remove the disc in the tray. The tray position can be toggled using the OPEN/CLOSE key. The tray will be closed (by the software, if it is open) before proceeding to the next test when the user presses the PLAY key.

5.5.9 Error Log (See Table on Page 25)

Reading the error log and error bits information can be useful to determine any errors that occurred recently during normal operation of the DVD player. Reading the error log is done by nucleus LogReadErr.

The display during the errorlog readout looks as follows :

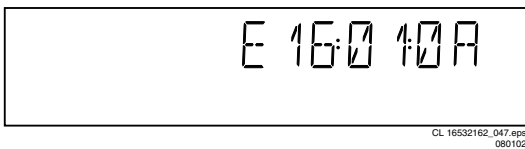

Figure 5-30

Note: Previous versions of the diagnostic software showed a 8-digit error code.

Due to limitations in the number of digits that can be displayed by some front panel displays, the most significant digits will not be shown. This can be done since all the error codes used by this player has set these 2 digits to "00"

By pressing OPEN/CLOSE or STOP the user can move forward or backward (respectively) through the logged error codes. If "0000" is displayed at all positions, the error log is empty. Display of the logged errors is done in a cyclic manner. By pressing PLAY on the local keyboard, the user can proceed to the next test.

5.5.10 Error Bits

Reading the error bits is done by nucleus LogReadBits. The display during the errorbits readout looks as follows:

5.6 Loop Test (See Table Below)

At the start of the loop test, the local display of the DVD player will show the interactive player test result readout in the following display:

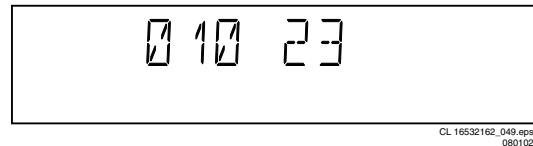

Figure 5-32

The left side of the display contains a 3-digit code, which can have a value between 000 and 111. These values indicate the faulty modules and are to be interpreted as follows:

Displayed Value	Indication for each module		
	Basic Engine	Mono PCB	Display PCB
000	ok	ok	ok
001	ok	ok	faulty
010	ok	faulty	ok
011	ok	faulty	faulty
100	faulty	ok	ok
101	faulty	ok	faulty
110	faulty	faulty	ok
111	faulty	faulty	faulty

CL 96532065_031.eps
120799

Figure 5-33

The loop test will perform the same nuclei as the dealer test, but it will loop through the list of nuclei indefinitely. The display of the DVD player will display not only the three digits indicating correct/faulty modules and the last found error code (as mentioned, faults are detected as far as they can be within the scope of the diagnostic software), but also a loop counter indicating how many times the loop has been gone through. If an error was detected, the display will remain as in figure 5-34 until the user presses the PLAY key and then it will continue to the next loop.

Example:

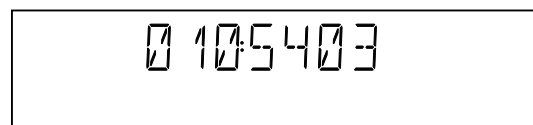

Figure 5-34

The 2-digit number (23) on the right of figure 5-32 indicates the number of times the loop test has been performed.

After one loop cycle: Display the 3-digit module bits together with the last error code which occurred in the loop test. The 4 digits at the right side of the display (fig. 5-34) show the last error that was found during the loop test. The leftmost two digits (54) of this code indicates which nucleus resulted in a fault. The rightmost two digits (03) refer to the faultcode within that nucleus. For further explanation of this error code, refer to chapter 5.8 (Nuclei Error Codes).

5.6.1 Errorlog

Explanation:

The application errors will be logged in the NVRAM. The maximum number of error bytes that will be visible is 16. The first word (4 digits) of the byte is the component identification, the last word is the error code.

The diagnostics software will present a combination of this component identification plus an error code on the local display (and on the attached terminal). The last reported error is shown as < 00000000, the oldest visible error as 00000000 > and the errors in between as < 00000000 >.

The devices that may report errors are the serial controller (UART), the basic engine (BE), the slave processor (SLPH), the SACD Stream Manager (SSM) and the SACD Media Access (SMA). The identification of these components is as follows:

Component name	Component identification
Serial controller (UART)	000A
Engine (BE)	0016
Slave Processor (SLPH)	001A
SACD Stream Manager (SSM)	001C
SACD Media Access (SMA)	002E
Diagnostic software (DS)	Dxxx

The tables in the next chapters list the error code and corresponding problem. The column 'Explanation' holds a more elaborate description and the most likely reason for the error.

Some Examples:

002E0000 (SMA reported a timeout error)
 0016010A (Engine could not fully close or open the tray)
 D0010001 (Flash checksum failed).

For further explanation of DS errors, see description of nuclei error codes in paragraph 5.8.

UART Error Codes

Error Number	Error name	Explanation
0000	BUF_OVE RFLOW	To many characters were offered in too little time. Reason: system was too busy doing other jobs.
0001	COMMUNI CATION	Usually a protocol error. Reason: bad connection between engine and processor.
0002	TIME OUT	

BE Errors

Error Number	Error name	Explanation
0101	S2B_ILL_CO MMAND	Parameter(s) not valid for this command. Reason: some communication problem between UART and engine.
0102	S2B_ILL_PAR AM	Command not allowed in this state or unknown. Reason: see S2B_ILL_COMMAND error

Error Number	Error name	Explanation
0103	S2B_SLEDGE	Sledge could not be moved to home position.
0104	S2B_FOCUS	Focus failure
0105	S2B_MOTOR	Motor could not reach speed within timeout
0106	S2B_RADIAL	Servo didn't get on track after several retries.
0107	S2B_PLL_LO CK	PLL could not lock in Accessing or Tracking state
0108	SBC_HEADE R_TO	Header timeout
0109	S2B_SBC_NO T_FOUND	Requested subcode item could not be found.
010A	S2B_TRAY	Tray could not be opened or closed completely.
010B	S2B_TOC_RE AD	TOC could not be read within timeout period.
010C	S2B_JUMP	Requested seek could not be performed.
010D	S2B_NON_EX IST_SES	Attempt to access a non-existing session.
010E	S2B_NON_EX IST_BCA	Caller tries to acces a non-existing BCA area
010F	Speed setting	A wrong or inappropriate speed value has been set
0116	NO_DISC	No disc selected
011A	TRAY_INIT	After reset, initialized tray
011B	NO TOC INFO	No TOC information in lead-in area or erase TOC found
01F0	S2B_OVERR UN	Too many bytes received over S2B Reason: see S2B_ILL_COMMAND error
01F1	S2B_COMM_ TO	Not enough bytes are received over S2B Reason: see S2B_ILL_COMMAND error
01F2	S2B_PARITY	Byte received with parity error. Reason: see S2B_ILL_COMMAND error
01F3	S2B_ILL_PHA SE	CMD IDC is not valid, transmission out of sync. Reason: see S2B_ILL_COMMAND error
01F4	S2B_ILL_NR_ OF_BYTES	Byte count has an illegal value. Reason: see S2B_ILL_COMMAND error

SLPH Error Codes

Error Number	Error name	Explanation
0000	COMMUNICA TION	Error in I2C communication. Reason: bad connection between slave processor and main processor.

SSM Error Codes

Error Code	Error name	Explanation
0006	SP_SYNCER ROR	System cannot get synchronised with sectors coming from disc. Reason: Usually a damaged disc or the player was dropped/pushed during operation. If not, the engine is malfunctioning.
0007	SP_EDCERR OR	Data coming from disc is damaged. Reason: see SP_SYNCERROR

Error Code	Error name	Explanation
0008	SP_CONTINUITYERROR	Sequence of sectors coming from disc is incorrect. Reason: see SP_SYNCERROR
0009	DMX_CONTINUITYERROR	Sequence of sectors is incorrect. Reason: problem with buffer RAM
000A	LLD_ERROR	An illegal audio format was offered to the decoder. Reason: unknown audio type on disc or problem with buffer RAM
000B	BCU_ERROR	Internal problem in Furore chip

SMA Error Codes

Error Number	Error name	Explanation
0000	SMA_TIMEOUTERROR	Data coming from disc not in time. Reason: damaged disc or engine problem.

5.6.2 Reprogramming of New Mono Boards.**Caution**

This information is confidential and may not be distributed. Only a qualified service person should reprogram the mono board.

After reset of NV-memory or repair of the mono board, all the customer settings and also the region code will be lost.

Reprogramming of the mono board will put the player back in the state in which it has left the factory, i.e. with the default settings and the allowed region code.

Reprogramming is limited to 25 times

When the counter reaches 25, reprogramming is not possible anymore

Reprogramming will be done by way of the remote control.

Put the player in stop mode, no disc loaded.

Press the following keys on the remote control:

<PLAY> followed by numerical keys <1> <5> <9>

The display shows: “-----”

Press now successively the following keys :

for DVD723 /001 /021 /051 : <2><2><2> <0><0><2><0><0>
for DVD743 /001 /021 /051 : <2><2><2> <0><0><3><0><0>

Press <PLAY> again.

The TV screen will become BLUE during a short time to confirm that the mono board has been reprogrammed.

Figure 5-35

5.6.3 Trade Mode

When the player is in Trade Mode, the player cannot be controlled by means of the front key buttons, but only by means of the remote control.

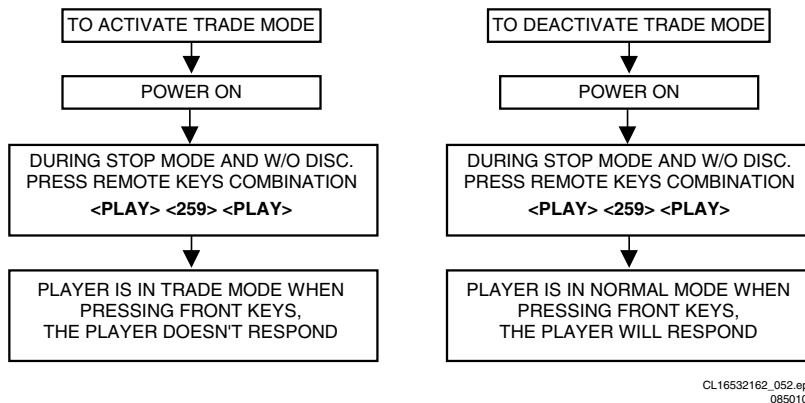

Figure 5-36

Note: To activate and deactivate the Trade Mode with the disc in the player, the procedure is similar to above, except that the remote control keys combination is pressed at the instant when the local display is flashing “READING”

5.7 Menu and Command Mode Interface

5.7.1 Layout of Results Diagnostic Nuclei

Results returned from a Diagnostic Nucleus will be displayed in the following layout:

< number >< string > [ok | ER]

< number >: is a 4-digit decimal number padded with leading zeros if its value is less than 4 digits. The first 2 digits identify the generating nucleus (or group of nuclei) while the latter 2 digits indicate the error number.

< string >: is a text string containing information about the result of the Diagnostic Nucleus.

< number > and < string > are defined in [SSD_DN] in the output sections of each Nucleus.

Examples:

1. 0001Unknown command ER @
2. 3100OK @
3. 0901Data line X is not connected to the DRAM ER@

5.7.2 Command Mode Interface

Set-up Physical Interface Components

Hardware required:

- Service PC
- one free COM port on the Service PC
- special cable to connect DVD player to Service PC

The service PC must have a terminal emulation program (e.g. OS2 WarpTerminal or Procomm) installed and must have a free COM port (e.g. COM1). Activate the terminal emulation program and check that the port settings for the free COM port are: 19200 bps, 8 data bits, no parity, 1 stop bit and no flow control. The free COM port must be connected via a special cable to the RS232 port of the DVD player. This special cable will also connect the test pin, which is available on the connector, to ground (i.e. activate test pin).

Code number of PC interface cable: 3122 785 90017

Activation

Switch the player on and the following text will appear on the screen of the terminal (program):

```

DVDv4 Diagnostic Software version 4.03
SDRAM Interconnection test passed
Basic SDRAM test passed
Front Panel Processor: SLAVE 4

(M)enu, (C)ommand (F)lash lguana or(S) 2B-interface?[M]:@ c
DD:>
  
```

CL 16532162_053.eps
080102

Figure 5-37

The first line indicates that the Diagnostic software has been activated and contains the version number. The next lines are the successful result of the SDRAM interconnection test and the basic SDRAM test. The last line allows the user to choose between the three possible interface forms. If pressing C has made a choice for Command Interface, the prompt (“DD>”) will appear. The diagnostic software is now ready to receive commands. The commands that can be given are the numbers of the nuclei.

Command Overview of Nuclei

The following table gives an overview of all available nuclei. The first column contains an identification number, the second contains the name of a nucleus and the last column indicate the description of the nucleus.

Note: User confirmation is necessary during front panel tests

Basic Diagnostic Nuclei

Ref. #	Reference Name	Remark
1	BasicSpAcc	Serial port Access test/ initialization
2a	BasicInterconDram	Data and address bus Interconnection (only for development)
2b	BasicInterconSdram	Data and address bus interconnection
3	BasicDramWrR	DRAM Write Read (only for development)
4	BasicSdramWrR	SDRAM Write Read

Processor and Peripherals

Ref. #	Reference Name	Remark
6	PapChksFl	Checksum FLASH
8a	PapSgsAckCdda	Internal PLL CLK in CD-DA mode

Ref. #	Reference Name	Remark
8b	PapSgsAclkDvd	Internal PLL CLK in DVD mode
8c	PapSgsAclkDvd96	Internal PLL CLK in DVD (96kHz) mode
10	PapFlashWrAcc	FLASH Write Access (only for development)
11	PapI2cNvram	I2C NVRAM access
12	PapI2cDisp	I2C Display PWB
13	PapS2bEcho	S2B Echo
14	PapS2bPass	S2B Pass-through
15	PapNvramWrR	NVRAM Write Read
62	PapChksSum	Show checksums stored in flash

Components

Ref. #	Reference Name	Remark
16	CompSdramWrR	SDRAM Write Read

Audio

Ref. #	Reference Name	Remark
18a	AudioDeemp0On AudioDeempOn (DVD2B)	Audio De-emphasis 0 On Audio De-emphasis On (DVDv2B)
18b	AudioDeemp0Off AudioDeempOff (DVD2B)	Audio De-emphasis 0 Off Audio De-emphasis Off (DVDv2B)
19a	AudioMuteOn	Audio Mute On
19b	AudioMuteOff	Audio Mute Off
20a	AudioPinkNoiseOn	Audio Pinknoise On
20b	AudioPinkNoiseOff	Audio Pinknoise Off
21a	AudioSineOn	Audio Sine signal On/Off
21b	AudioSineBurst	Audio Sine signal Burst
56a	AudioLfePortHigh	Set the LFE_SEL port to HIGH
56b	AudioLfePortLow	Set the LFE_SEL port to LOW

Video

Ref. #	Reference Name	Remark
17a	VidPortOutAA	Output the value 0XAA at the Digital Video Interface Port
17b	VidPortOut55	Output the value 0X55 at the Digital Video Interface Port
23a	VideoColDencOnPAL	Colourbar (PAL) DENC On
23b	VideoColDencOff	Colourbar DENC Off
23c	VideoColDencOnNTSC	Colourbar (NTSC) DENC On
24a	VideoProgMPEGon	Progressive - DigitalVideo Colour Bar ON
24b	VideoYuvMPEGon	Enhanced YUV - DigitalVideo Colour Bar
25a	VideoScartLo	Scart Low
25b	VideoScartMi	Scart Medium
25c	VideoScartHi	Scart High
54	VideoScartSwComm	Scart Switch communication
55a	VideoScartSwDvd	Scart Switch Dvd
55b	VideoScartSwPass	Scart Switch Pass-through
57a	VideoScartPinLo	PIO-pins as used in 2A for Scart-switching

Ref. #	Reference Name	Remark
57b	VideoScartPinMi	PIO-pins as used in 2A for Scart-switching
57c	VideoScartPinHi	PIO-pins as used in 2A for Scart-switching
61a	VideoColOutRGB (ST5508)	Output RGB from ST5508
61b	VideoColOutYUV (ST5508)	Output YUV from ST5508

Display PWB (Slave Processor)

Ref. #	Reference Name	Remark
26	DispVer	Version number
27	DispKeyb	Keyboard
28	DispRc	Remote Control
29	DispLed	LEDs
30a	DispDisplay	VFT Display test
30b	DispLCDisplay	LCD Display test
30c	DispLCDBkLight	LCD Backlight test
60	DispP50	P50 loopback test

Log (Error Logging In NVRAM)

Ref. #	Reference Name	Remark
31	LogReadErr	Read last Errors
32	LogReadBits	Read errors Bits
33	LogReset	Reset

Miscellaneous

Ref. #	Reference Name	Remark
34	MiscReadConfig	Read Configuration area from NVRAM
35	MiscNvramReset	NVRAM Reset
36	MiscNvramMod	Modify NVRAM contents
46	MiscApplVer	Read version of application software
47a	MiscTrayOpenNr	Read the number of times the tray opened
47b	MiscPowerOnTime	Read the total time the player's power has been on
47c	MiscPlayTimeCddaVcd	Read the Playtime of CDDA and VCD discs
47d	MiscPlayTimeDvd	Read the Playtime of DVD discs

Basic Engine

Ref. #	Reference Name	Remark
37	BeVer	Version number
38a	BeFocusOn	Focus On
38b	BeFocusOff	Focus Off
39a	BeDiscmotorOn	Discmotor On
39b	BeDiscmotorOff	Discmotor Off
40a	BeRadialOn	Radial control On
40b	BeRadialOff	Radial control Off
41a	BeSledgeIn	Sledge Inwards
41b	BeSledgeOut	Sledge Outwards
42a	BeGroovesIn	jump Grooves to Inside
42b	BeGroovesMid	jump Grooves to Middle
42c	BeGroovesOut	jump Grooves to Outside
43a	BeTrayIn	Tray In
43b	BeTrayOut	Tray Out
44	BeReset	Reset Basic Engine
58a	LaserCdOn	CD Laser on
58b	LaserCdOff	CD Laser off
58c	LaserDvdOn	DVD Laser on
58d	LaserDvdOff	DVD Laser off
59	AudioDtsCheckComm	Check I2C communication with Motorola DSP chip

Karaoke (Not Available)

Ref. #	Reference Name	Remark
48a	KaraokeModeOff	Switch Karaoke mode off
48b	KaraokeModeOn	Switch Karaoke mode on
49	KaraokeMicInput	Check path from the microphone input to audio output
50a	KaraokeKeyOn	Set Karaoke Key to the maximum level (1200 cent)
50b	KaraokeKeyOff	Set Karaoke Key to flat octave (0 cent)
51a	KaraokeEchoOn	Set Echo Control function on
51b	KaraokeEchoOff	Set Echo Control function off

5.7.3 Menu Mode Interface**Activation**

Switch the player on and the following text will appear on the screen of the terminal (program):

```

DVDv4 Diagnostic Software version 4.03

SDRAM Interconnection test passed
Basic SDRAM test passed
Front Panel Processor: SLAVE 4

(M)enu, (C)ommand (F)lash lguana or(S) 2B-interface?[M]:@ M
                                     ↓
Press enter to go to main menu
CC:>
MAIN MENU

1  Audio          ---
2  Video          ---
3  Front Panel   ---
4  Basic Engine   ---
5  Processor Peripheral ---
6  Error Log     ---
7  Miscellaneous ---

Select>

```

CL 16532162_054.dps 080102

Figure 5-38

The first line indicates that the Diagnostic software has been activated and contains the version number. The next lines are the successful result of the SDRAM interconnection test and the basic SDRAM test. The last line allows the user to choose

between the four possible interface forms. If pressing M has made a choice for Menu Interface, the Main Menu will appear.

Layout of Menu and Submenu

The following menu layout will appear after starting up the DVD player in menu mode. The symbol “- - -” indicates that the current menu choice will invoke the display of a submenu. The number between [] indicates the nucleus number. These numbers will not be shown on the screen.

Menus**MAIN MENU**

- 1 Audio...
- 2 Video...
- 3 Front Panel...
- 4 Basic Engine...
- 5 Processor Peripherals...
- 6 Error Log...
- 7 Miscellaneous...

First Level Submenus**MAIN > AUDIO MENU**

- 1 Mute...
- 2 Pink Noise...
- 3 Sine Wave...
- 4 Digital Ports...

MAIN > VIDEO MENU

- 1 Colourbar...
- 2 Scart...
- 3 Digital Port...

MAIN > FRONT PANEL MENU

- 1 Slave Processor...
- 2 VFT Display [30a]
- 3 LCD Display [30b]
- 4 LCD BkLight [30c]
- 5 Keyboard [27]
- 6 LEDs [29]
- 7 Remote Control [28]
- 8 P50 Check [60]

MAIN > BASIC ENGINE MENU

- 1 Reset [44]
- 2 Version [37]
- 3 S2B...
- 4 Loader Mechanism...
- 5 Special Diagnostics...

MAIN > PROCESSOR PERIPHERALS MENU

- 1 Clock...
- 2 Flash...
- 3 NVRAM...
- 4 SDRAM Write/Read [16]

MAIN > ERROR LOG MENU

- 1 Read Last Errors [31]
- 2 Read Error Bits [32]
- 3 Reset Error Log [33]

MAIN > MISCELLANEOUS MENU

- 1 Statistics Info...
- 2 Read DVD Application version [46]

Second Level Submenus**MAIN > AUDIO > MUTE MENU**

- 1 Mute On [19a]
- 2 Mute Off [19b]

MAIN > AUDIO > PINK NOISE MENU

- 1 Pink Noise On [20a]
- 2 Pink Noise Off [20b]

MAIN > AUDIO > SINE WAVE MENU

- 1 Audio Sine On [21a]
- 2 Audio Burst On [21b]

MAIN > AUDIO > DIGITAL PORTS MENU

- 1 LFE_SEL High [56a]
- 2 LFE_SEL Low [56b]

MAIN > VIDEO > COLOURBAR MENU

- 1 Colourbar DENC On (PAL) [23a]
- 2 Colourbar DENC On (NTSC) [23c]
- 3 Colourbar DENC/MPEG Off [23b]
- 4 ProgressiveScan MPEG On [24a]
- 5 Enhanced YUV MPEG On [24b]
- 6 Set Video Out To RGB [61a]
- 7 Set Video Out To YUV [61b]

MAIN > VIDEO > SCART MENU

- 1 I2C Scart IC Check [54]
- 2 Scart To DVD [55a]
- 3 Scart Pass Through [55b]
- 4 Scart Pin 8 Low (0 to 2)V [25a]
- 5 Scart Pin 8 Mid (4.5 to 7)V [25b]
- 6 Scart Pin 8 Hi(9.5 to 12)V [25c]

MAIN > VIDEO > DIGITAL PORT MENU

- 1 Video Port Out 0xAA [17a]
- 2 Video Port Out 0x55 [17b]

MAIN > FRONT PANEL > SLAVE PROCESSOR MENU

- 1 Bus Comms Check [12]
- 2 S/W Version [26]

MAIN > BASIC ENGINE > S2B MENU

- 1 S2B Echo [13]
- 2 S2B Pass-Through [14]

MAIN > BASIC ENGINE > MECHANISM MENU

- 1 Disc Motor...
- 2 Laser...
- 3 Tray...
- 4 Focus...
- 5 Radial...
- 6 Sledge...
- 7 Grooves...

MAIN > BASIC ENGINE > SPECIAL DIAGNOSTICS MENU

- 1 Read FlashID [70]
- 2 ROM Checksum [71]

MAIN > PROCESSOR PERIPHERALS > PCM CLOCK MENU

- 1 PCM_CLK In CDDA Mode (11.3MHz) [8a]
- 2 PCM_CLK In DVD Mode (12.3MHz) [8b]
- 3 PCM_CLK In DVD96kHz Mode (24.6MHz) [8c]

MAIN > PROCESSOR PERIPHERALS > FLASH MENU

- 1 Verify FLASH Checksum [6]
- 2 Show FLASH Checksum [62]
- 3 Flash Write Access [10]

MAIN > PROCESSOR PERIPHERALS > NVRAM MENU

- 1 NVRAM Config [34]
- 2 NVRAM Reset [35]
- 3 NVRAM Modify [36]
- 4 NVRAM Read/Wr Test [15]

MAIN > MISCELLANEOUS > STATISTICS INFO MENU

- 1 Total Nr Of Times Tray Open [47a]

- 2 Total Time Power On [47b]
- 3 Total Play-Time CDDA & VCD [47c]
- 4 Total Play-Time DVD [47d]

Third Level Submenus*MAIN > BASIC ENGINE > MECHANISM > DISC MOTOR MENU*

- 1 Disc Motor On [39a]
- 2 Disc Motor Off [39b]

MAIN > BASIC ENGINE > MECHANISM > LASER MENU

- 1 CD Laser On [58a]
- 2 CD Laser Off [58b]
- 3 DVD Laser On [58c]
- 4 DVD Laser Off [58d]

MAIN > BASIC ENGINE > MECHANISM > TRAY MENU

- 1 Tray Open [43b]
- 2 Tray Close [43a]

MAIN > BASIC ENGINE > MECHANISM > FOCUS MENU

- 1 Focus On [38a] (load DVD first)
- 2 Focus Off [38b]

MAIN > BASIC ENGINE > MECHANISM > RADIAL MENU

- 1 Radial Control On [40a] (load DVD first)
- 2 Radial Control Off [40b]

MAIN > BASIC ENGINE > MECHANISM > SLEDGE MENU

- 1 Sledge Inwards [41a]
- 2 Sledge Outwards [41b]

MAIN > BASIC ENGINE > MECHANISM > GROOVES (Uses DVD) MENU

- 1 Jump ToInside Grooves [42a]
- 2 Jump ToMiddle Grooves [42b]
- 3 Jump To Outside Grooves [42c]

5.8 Nuclei Error Codes

In the following tables the error description of the error codes will be described.

5.8.1 Audio Nuclei

Error code	Error text
1880	Test successful
1800	Test successful
1900	Test successful
1920	Test successful
2000	Test successful
2020	Test successful
2100	Test successful
5600	Test successful
5620	Test successful

5.8.2 Basic Engine Nuclei

Error code	Error text
3900	Test successful
3901	"Parity error from Basic Engine to Serial"
3902	"Unexpected response from Basic Engine"
3903	"Communication time-out error"
3904	"Basic Engine returned error number 0xXX"
3921	"Parity error from Basic Engine to Serial"
3922	"Unexpected response from Basic Engine"
3923	"Communication time-out error"
3924	"Basic Engine returned error number 0xXX"
3800	Test successful
3801	"Parity error from Basic Engine to Serial"
3802	"Unexpected response from Basic Engine"
3803	"Communication time-out error"
3804	"Basic Engine returned error number 0xXX"
3805	"Focus loop could not be closed"
3820	Test successful
3821	"Parity error from Basic Engine to Serial"
3822	"Unexpected response from Basic Engine"
3823	"Communication time-out error"
3824	"Basic Engine returned error number 0xXX"
4200	Test successful
4201	"Parity error from Basic Engine to Serial"
4202	"Unexpected response from Basic Engine"
4203	"Communication time-out error"
4204	"Basic Engine returned error number 0xXX"
4205	"Sledge could not be moved to home position"
4206	"Focus loop could not be closed"
4207	"Motor not on speed within time-out"
4208	"Radial loop could not be closed"
4209	"PLL could not lock in accessing or tracking state"
4210	"Subcode or sector information could not be read"
4211	"Requested subcode item could not be found"
4212	"TOC could not be read in time"
4213	"Seek could not be performed"
4220	Test successful
4221	"Parity error from Basic Engine to Serial"
4222	"Unexpected response from Basic Engine"
4223	"Communication time-out error"
4224	"Basic Engine returned error number 0xXX"
4225	"Sledge could not be moved to home position"
4226	"Focus loop could not be closed"
4227	"Motor not on speed within time-out"
4228	"Radial loop could not be closed"
4229	"PLL could not lock in accessing or tracking state"
4230	"Subcode or sector information could not be read"
4231	"Requested subcode item could not be found"
4232	"TOC could not be read in time"
4233	"Seek could not be performed"
4240	Test successful
4241	"Parity error from Basic Engine to Serial"

Error code	Error text
4242	"Unexpected response from Basic Engine"
4243	"Communication time-out error"
4244	"Basic Engine returned error number 0xXX"
4245	"Sledge could not be moved to home position"
4246	"Focus loop could not be closed"
4247	"Motor not on speed within time-out"
4248	"Radial loop could not be closed"
4249	"PLL could not lock in accessing or tracking state"
4250	"Subcode or sector information could not be read"
4251	"Requested subcode item could not be found"
4252	"TOC could not be read in time"
4253	"Seek could not be performed"
4000	Test successful
4001	"Parity error from Basic Engine to Serial"
4002	"Unexpected response from Basic Engine"
4003	"Communication time-out error"
4004	"Basic Engine returned error number 0xXX"
4005	"Radial loop could not be closed"
4020	Test successful
4021	"Parity error from Basic Engine to Serial"
4022	"Unexpected response from Basic Engine"
4023	"Communication time-out error"
4024	"Basic Engine returned error number 0xXX"
4400	Test successful
4401	Test successful
4100	Test successful
4101	"Parity error from Basic Engine to Serial"
4102	"Unexpected response from Basic Engine"
4103	"Communication time-out error"
4104	"Basic Engine returned error number XX"
4120	Test successful
4121	"Parity error from Basic Engine to Serial"
4122	"Unexpected response from Basic Engine"
4123	"Communication time-out error"
4124	"Basic Engine returned error number XX"
4300	Test successful
4301	"Parity error from Basic Engine to Serial"
4302	"Unexpected response from Basic Engine"
4303	"Communication time-out error"
4304	"Basic Engine returned error number 0xXX"
4320	Test successful
4321	"Parity error from Basic Engine to Serial"
4322	"Unexpected response from Basic Engine"
4323	"Communication time-out error"
4324	"Basic Engine returned error number 0xXX"
3700	"Version: X.Y.Z"
3701	"Parity error from Basic Engine to Serial"
3702	"Unexpected response from Basic Engine"
3703	"Communication time-out error"
3704	"Basic Engine returned error number 0xXX"
5800	Test successful

Error code	Error text
5820	Test successful
5840	Test successful
5860	Test successful
5801	"Unexpected response from Basic Engine"
7000	"Manuf. ID: <XX>" "Device ID: <YY>"
7001	"Comm Test Failed"
7002	"Load Cmd Failed"
7003	"Load Dat Failed"
7004	"Run Cmd Failed"
7100	"ROM Checksum: XXXX"
7101	"Comm Test Failed"
7102	"Load Cmd Failed"
7103	"Load Dat Failed"
7104	"Run Cmd Failed"

5.8.3 Display PWB Nuclei

Error code	Error text
3000	"Test successful"
3001	"Disp not responding"
3002	"Disp key no response"
3003	"One or more patterns not correct"
3004	"Disp type invalid"
3020	"Test successful"
3021	"Disp not responding"
3022	"Disp key no response"
3023	"One or more patterns not correct"
3040	"Test successful"
3041	"Disp not responding"
3042	"Disp key no response"
3043	"One or more patterns not correct"
2700	"Model name in wich the test is running"
2701	"Disp key no response"
2702	"Disp not responding"
2707	"Stop key not pressed"
2708	"Pause key not pressed"
2709	"Play key not pressed"
2710	"Open/close key not pressed"
2713	"Previous key not pressed"
2714	"Next key not pressed"
2715	"More than one key not pressed"
2716	" Audio key not pressed"
2900	"Test successful"
2901	"Slave not responding"
2902	"Slave keyboard not responding"
2903	"Standby led not working"
2800	"Test successful"
2801	"Slave display controller not responding"
2802	"Slave keyboard not responding"
2803	"No key press received from remote control"
2600	"The ROM version of the slave processor = 0xXX, and the internal ID = 0xYY"
2601	"I2c bus busy"
2602	"I2c bus not working"
6000	P50 test

Error code	Error text
6001	"No readback on P50"
6002	"Disp not responding "
6003	"P50 readback error"

5.8.4 Processor & Peripherals Nuclei

Error code	Error text
700	Test successful
720	Test successful
740	Test successful
600	"All checksums are correct"
601	"Following checksum is faulty: BootCode1 Checksum is 0xY2 and is not correct (must be 0xZ2)"
601	"This test is not available when stand-alone compiled"
6200	"Checksums = 0xA1, 0xB1, 0xC1, 0xD1"
6201	"This test is not available when stand-alone compiled"
1000	Test successful
1001	Test successful
1020	Test successful
1021	Test successful
1100	Test successful
1104	"NVRAM reply time-out"
1200	Test successful
1202	"Slave bus not working"
1203	"Slave controller not responding"
1204	"Slave response is not correct"
5900	Test successful
5901	"I2c bus busy"
5902	"I2c bus not working"
5904	"DTS chip response not correct"
1300	Test successful
1301	"Parity error from basic engine to serial"
1302	"Parity error from serial to basic engine"
1303	"No communication between serial and basic engine"
1304	"Communication time-out error"
1600	Test successful
1601	"The DVD SDRAM is faulty"

5.8.5 Log Nuclei

Error code	Error text
3100	"Show error log"
3101	"Error log is invalid"
3102	"Error log could not be read from NVRAM"
3103	"I2C bus busy before start"
3200	"Show error bit"
3201	"Error log is invalid"
3202	"I2C bus busy before start"

Error code	Error text
3203	"Error log could not be read from NVRAM"
3300	"Error log is cleared"
3301	"Error log could not be cleared"
3302	"I2C bus busy before start"

5.8.6 Miscellaneous Nuclei

Error code	Error text
3400	Test successful
3401	"The configuration data could not be read from NVRAM"
3402	"I2C bus busy before start"
3500	"NVRAM is cleared"
3501	"The NVRAM could not be reset."
3502	"I2C bus busy before start"
3600	"NVRAM contents updated."
	"NVRAM contents and configuration checksum updated."
3601	"NVRAM contents could not be updated."
3602	"I2C bus busy before start"
3603	"NVRAM contents could not be read"
3604	"NVRAM not accessible."
3605	"NVRAM checksum could not be updated."
1500	Test successful
1502	"NVRAM access time-out"
1504	"NVRAM fails"
5400	Test successful
5401	"I2c bus busy"
5402	"I2c bus not working"
5403	"Scart switch controller not responding"
5404	"Scart switch controller response not correct"
5500	Test successful
5501	"I2c bus busy"
5502	"I2c bus not working"
5520	Test successful
5521	"I2c bus busy"
5522	"I2c bus not working"
5523	"Scart switch controller not responding"
5200	Test successful
5201	"I2c bus busy"
5202	"I2c bus not working"
5300	Test successful
5301	"I2c bus busy"
5302	"I2c bus not working"
5320	Test successful
5321	"I2c bus busy"
5322	"I2c bus not working"
4700	"Number of times Tray went Open : XX"
4701	The total number of times tray went open could not be read from NVRAM.
4702	I2C bus busy before start

Error code	Error text
4720	"Total Power On time (minutes) : XX"
4721	The total power-on time could not be read from NVRAM.
4722	I2C bus busy before start
4740	"Total CDDA & VCD disks Play-time (minutes) : XX"
4741	The playtime of CDDA & VCD disks could not be read from NVRAM.
4742	I2C bus busy before start
4760	"Total DVD disks Play-time (minutes) : XX"
4761	The playtime of DVD disks could not be read from NVRAM.
4762	I2C bus busy before start
4600	"Version of Application Software : XX"
4601	"The application version could not be read from NVRAM."
4602	"I2C bus busy before start"

5.8.7 Video Nuclei

Error code	Error text
2300	Test successful
2320	Test successful
2340	Test successful
2400	Test successful
2401	"I2c bus busy"
2421	"I2c bus busy"
2441	"I2c bus busy"
2500	Test successful
2501	"I2c bus busy"
2502	"I2c bus not working"
2520	Test successful
2521	"I2c bus busy"
2522	"I2c bus not working"
2540	Test successful
2541	"I2c bus busy"
2542	"I2c bus not working"
6100	Test successful
6100	Test successful

5.9 Test Instruction Front Display and Audio/ Video Board

These test instruction is designed specifically for LEAD 2002 models which has the following outputs:

- Audio L/R
- Coaxial / Optical digital output
- CVBS
- Single and double SCART output
- SVHS
- Front Display

5.9.1 General

- All the waveforms measurement carried out in these test instruction will be base on the testpoint indicated in the A/V Board and Front Display schematic diagram in the Service manual.
- Impedance of the measuring-equipment should be $> 1M\Omega$
- Most of the tests can be done using either the Diagnostic software "Player script" which can be found in the chapter "Diagnostic Software description and troubleshooting" or the Menu interface using the Service PC with a terminal emulation program (e.g. Window Hyperterminal) where it is possible to control the execution of the Diagnostic Nuclei
- Setup for the measurement will be done in set level with all modules connected as shown in the Wiring Block diagram.

5.9.2 General Start-Up Measurement

Supply Check:

Before starting the measurement,ensure that all power supply are connected to the A/V and Front Display board via conn.1101 and 1114/1133.

Pin nr.	A/V Board	Front Display
Voltage	Conn. 1101	Conn. 1114/1133
1	+3V3STBY	+5VSTBY
2	+3V3STBY	+12VSTBY
3	GND	GND
4	+12VSTBY	-32V
5	GND	-
6	+5VSTBY	-
7	GND	-
8	-8V	-

Clock Check

Ensure the present of the clock to the DAC and the μP .

Clock Name	Testpoint	Frequency
PCM_CLK	I173	11.2896MHz \pm 0.02% tolerance
XOUT	S1	8MHz \pm 0.2% tolerance

Audio Mute Check

Measure the Audio mute voltage input at pin 22 of connector 1100

Status	Value
AudioMuteOn	HIGH (>3V)
AudioMuteOff	LOW (<3V)

To toggle between ON and OFF,use the following commands:

Ref.#	Command Name	Remarks
19a	AudioMuteOn	Audio Mute On
19b	AudioMuteOff	Audio Mute Off

5.9.3 Audio DAC And Amplifier

Ensure that the Audio mute signal is OFF
To check the DAC and buffer amplifier,send the following commands:

Ref.#	Command Name	Remarks	Audio output
21a	AudioSineOn	Audio Sine signal ON	Sine,1Khz on stereo
----	Press stop button	Audio Sine signal OFF	No waveform
20a	AudioPinkNoiseOn	Audio Pinknoise ON	Pink Noise on 6 channels
20b	AudioPinkNoiseOff	Audio Pinknoise OFF	No waveform

The audio signal (sine or pink noise) will also be present on the digital output (SPDIF).This can be checked by connecting digital signal to an amplifier with digital input.

Check the I2S and audio signal at the following testpoints:

Name	Testpoint
PCM_LRCLK	I172
PCM_SCLK	I175
PCM_CLK	I173
PCM_DATA0	I174
PCM_DATA1	NA
PCM_DATA2	NA
DIG_OUT	I235
AUDIO L/R OUT	I226 / I236
FRONT L/R OUT	NA
SURROUND L/R OUT	NA
CENTRE OUT	NA
SUB WOOFER L/R OUT	I165

All waveforms can be refered to the A/V board schematic diagram.

5.9.4 Video Output And Buffer Amplifier

Check DC output-level at all video cinch output : 1.0V DC \pm 10%

Generate a color bar using the following software commands:

Ref.#	Command Name	Remarks
23a	VideoColDencOn	Colour DENC ON
23b	VideoColDencOff	Colourbar DENC OFF

Check the video outputs at the following testpoints:

Name	Testpoint
BLUE	I123
GREEN	I124
RED	I125
CVBS out	I180 / I195 / I145
S-Video-C out	I122
S-Video-Y out	I121

Il waveforms can be refered to the A/V board schematic diagram.

5.9.5 Play and 16/9 Detection

Check 0/6/12 signal on pin 8 of the SCART connector 1130 and change the input with the following commands:

Ref.#	Command Name	Remarks
25a	VideoScartLo	Sends out 0V \pm 0.5V
25b	VideoScartMi	Sends out 6V \pm 10%
25c	VideoScartHi	Sends out 12V \pm 10%

Since in SD4 based single SCART players, pin 8 output is determined by SCART0 and standby control signal. Since standby control must be LOW when diagnostic is running, we can only set pin 8 to 6V or 12 V.

5.9.6 Kill Circuit

To check the functionality of the Kill circuitry, the audio outputs has to be present by the following command:

Ref.#	Command Name	Remarks	Audio output
21a	AudioSineOn	Audio Sinewave ON	1kHz tone

Check the audio outputs at the audio cinch of the A/V board: 1kHz tone

Activate the Kill circuit by using the following command:

Ref.#	Command Name	Remarks
19a	AudioMuteOn	Audio Mute On

Check the audio outputs at the audio L/R cinch and SCART of the A/V board: No waveform

Switch off the kill circuit by using the following command:

Ref.#	Command Name	Remarks
19b	AudioMuteOff	Audio Mute Off

Check the audio outputs at the audio L/R cinch and SCART of the A/V board: 1kHz tone

5.9.7 Digital Silence

Digital silence is a signal from the audio DAC, KILL_LR, when there is no input to the audio DAC, or when the player is in STOP/PAUSE mode, or during disc changing track.

To check the KILL_LR signal, use the following command and check the voltage level at pin 16 of 7200:

Ref.#	Command Name	Remarks	KILL_LR signal
21a	AudioSineOn	Audio Sinewave ON	LOW (<0.3V)
---	Press STOP button	Audio Sine signal OFF	HIGH (>4.5V)

5.9.8 Front Display

To check the segment display of the FTD, the following command can be used. And for full detail description of the test, refer to the chapter of "Diagnostic Software Player Script" which can be found in chapter "Diagnostic Software Description and Troubleshooting"

Ref.#	Command Name	Remarks
30a	DispDisplay	Turn ON local display

5.9.9 IR Receiver

Check at pin 22 of 7101 and observe if this line switches from LOW (<0.3V) to HIGH (>4.5V) when pressing a key on a philips RC5 or RC6 remote control

5.9.10 P50 Interface (Only for DVD743 model)

P50 (or Easylink) is a bi-directional serial interface for communication between video equipment. To check for the functionality of the P50 Interface, refer to the chapter of 'Diagnostic Software Player Script' for full detail description.

6. Block and Wiring Diagram.

Block Diagram DVD723-743 EU

GENERAL BLOCK DIAGRAM FOR DVD723-743 EU

** Item number within () are only for DVD743EU

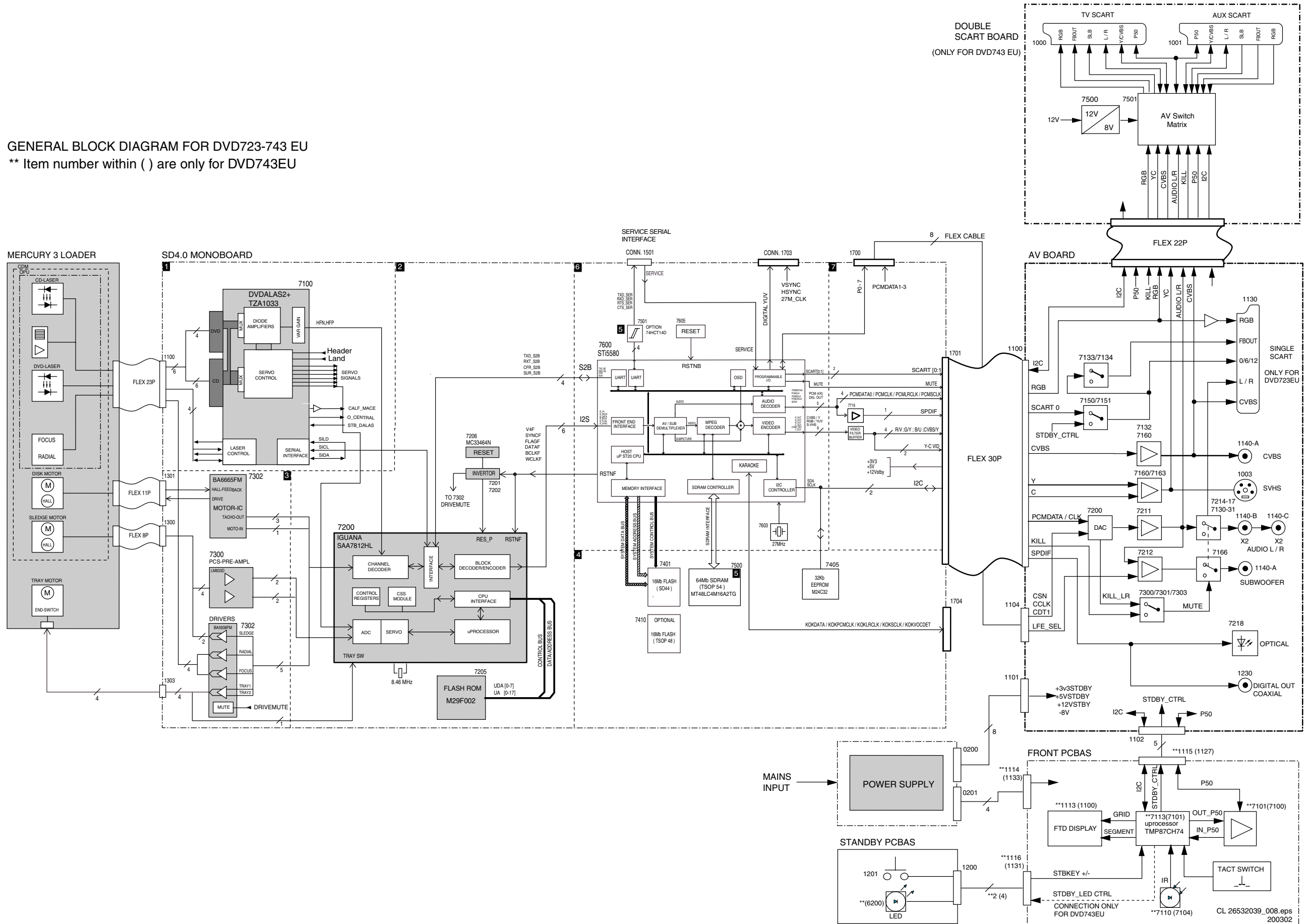

Wiring Diagram DVD723/0X1

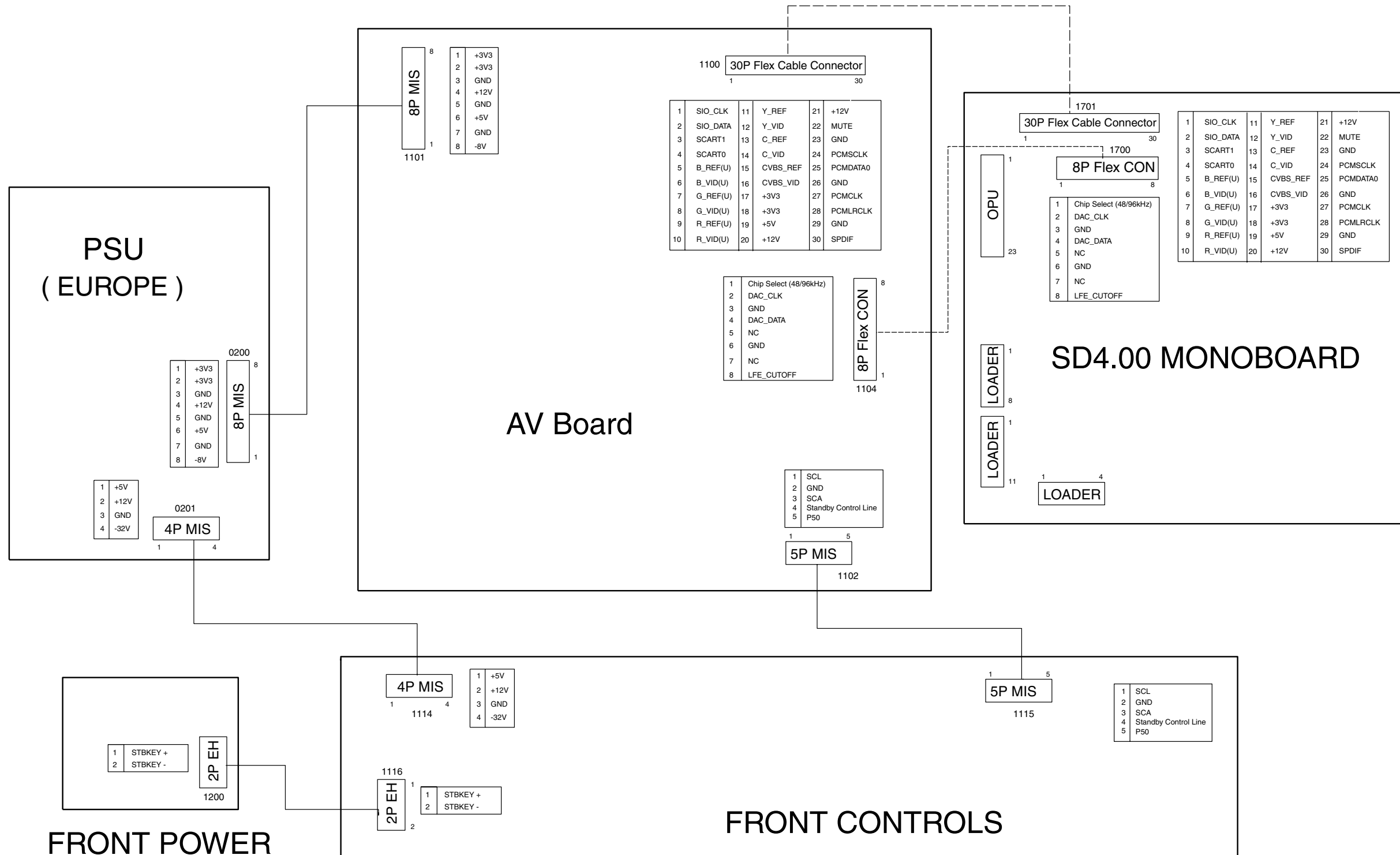

Wiring Diagram for DVD723/xx1

Wiring Diagram DVD743/0X1

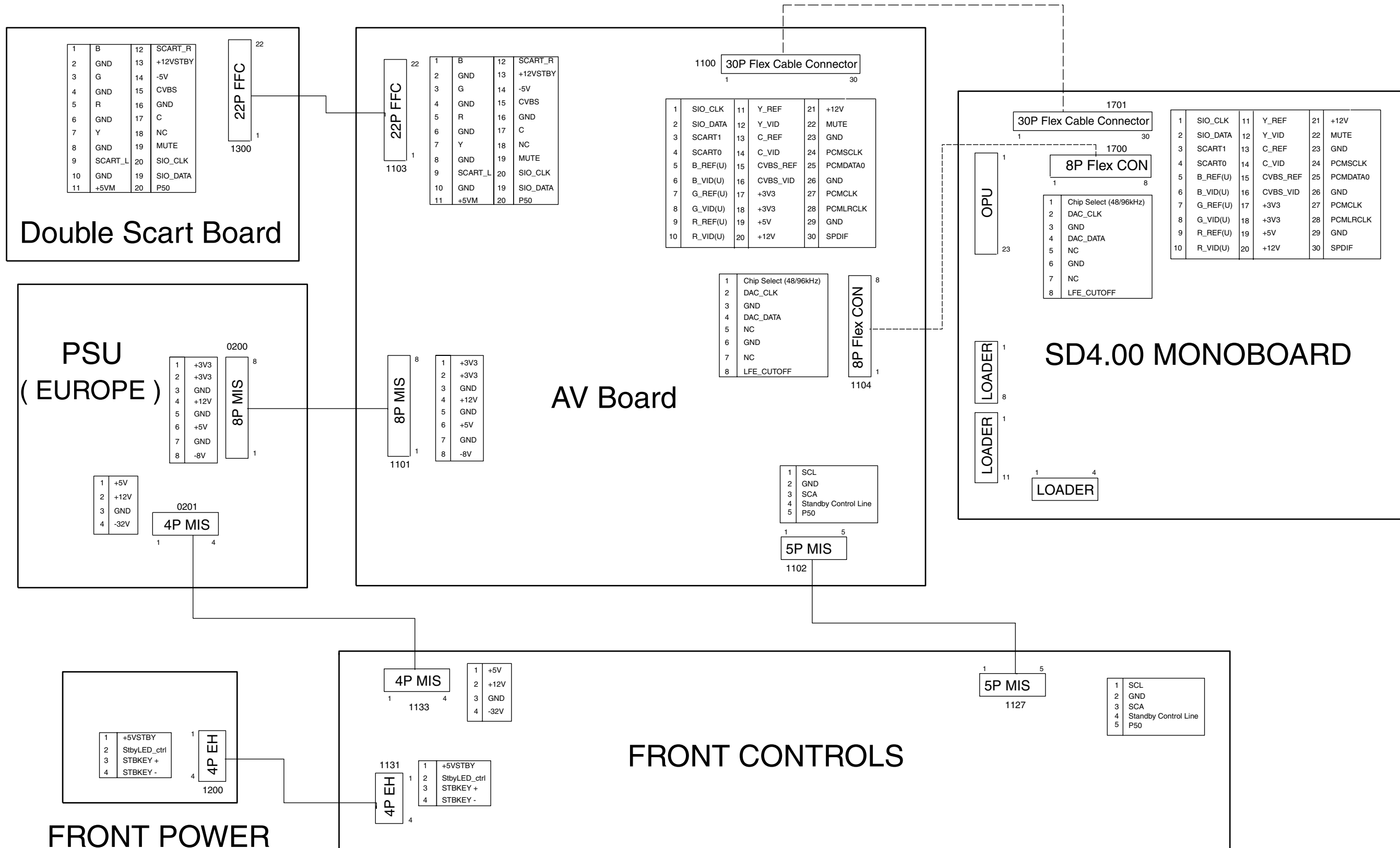

Wiring Diagram for DVD743/xx1

7. Electrical Diagrams

Power Supply Unit DVD723 EU

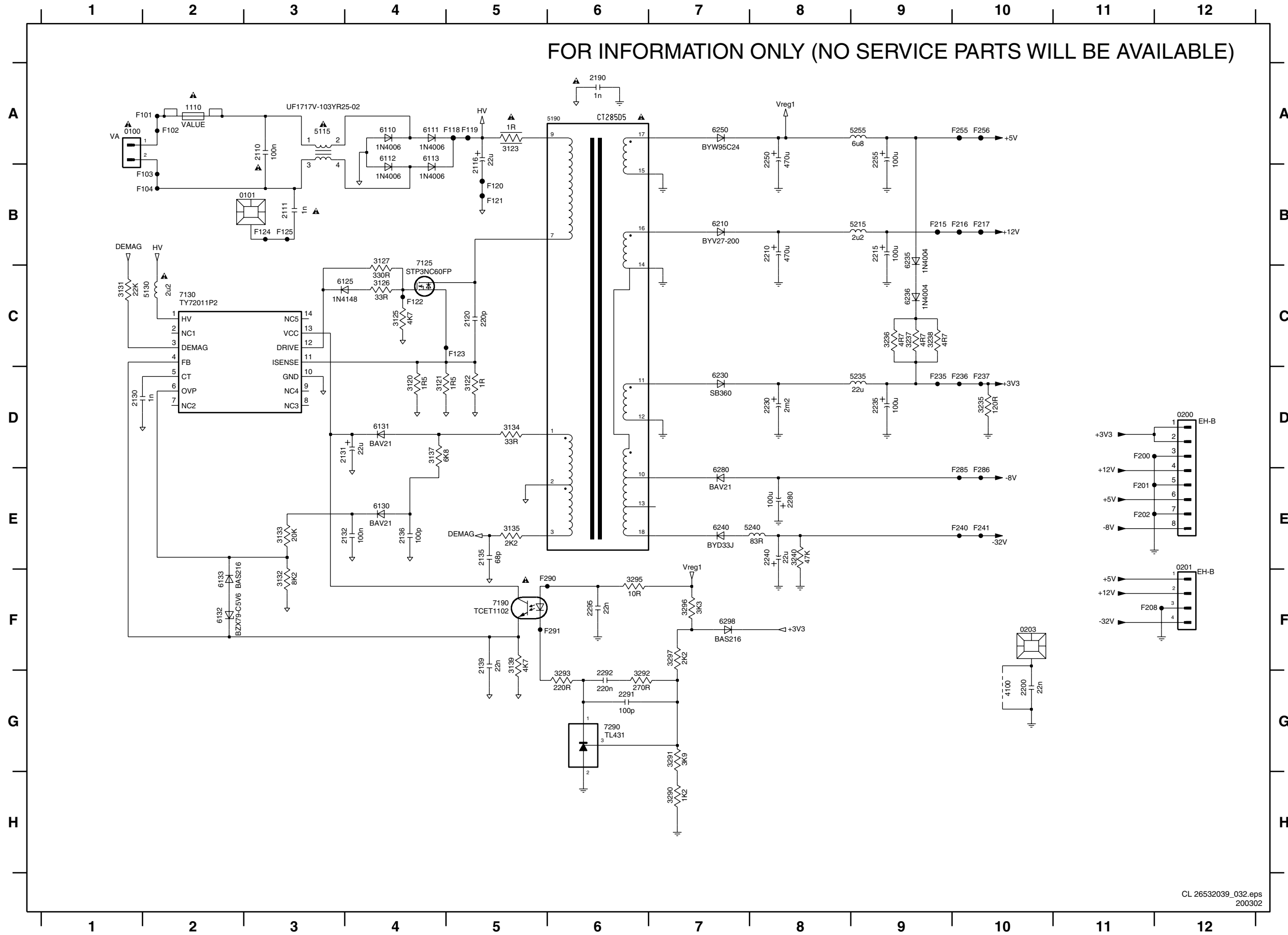

- 0100 A1
- 0101 B2
- 0200 D12
- 0201 F12
- 0203 F10
- 1110 A2
- 2110 A3
- 2111 B3
- 2116 B5
- 2120 C5
- 2130 D1
- 2131 D4
- 2132 E4
- 2135 E5
- 2136 E4
- 2139 F5
- 2190 A6
- 2200 G10
- 2210 B8
- 2215 B9
- 2230 D8
- 2235 D9
- 2240 E8
- 2250 A8
- 2280 E8
- 2291 G6
- 2292 G6
- 2295 F6
- 3120 D4
- 3121 D4
- 3122 D5
- 3123 A5
- 3125 C4
- 3126 C4
- 3127 B4
- 3131 C1
- 3132 F3
- 3133 E3
- 3134 D5
- 3135 E5
- 3137 D4
- 3139 F5
- 3235 D10
- 3236 C9
- 3237 C9
- 3238 C9
- 3240 E8
- 3290 H7
- 3291 G7
- 3292 G6
- 3293 G6
- 3295 F6
- 3296 F7
- 3297 F7
- 4100 G10
- 5115 A3
- 5130 C2
- 5190 A6
- 5215 B9
- 5235 D9
- 5240 E8
- 5255 A9
- 6110 A4
- 6111 A4
- 6112 A4
- 6113 A4
- 6125 C4
- 6130 E4
- 6131 D4
- 6132 F2
- 6133 F2
- 6210 B7
- 6230 D7
- 6235 B9
- 6236 C9
- 6240 E7
- 6250 A7
- 6280 E7
- 6298 F7
- 7125 C4
- 7130 C2
- 7190 F5
- 7290 G6
- F101 A2
- F102 A2
- F103 B2
- F104 B2
- F118 A5
- F119 A5
- F120 B5
- F121 B5
- F122 C4
- F123 C5
- F124 B3
- F125 B3
- F200 D11
- F201 E11
- F202 E11
- F208 F11
- F215 B9
- F216 B10
- F217 B10
- F235 D9
- F236 D10
- F237 D10
- F240 E10
- F241 E10
- F255 A10
- F256 A10
- F285 E10
- F286 E10
- F290 F6
- F291 F6

Power Supply DVD743 EU

FOR INFORMATION ONLY (NO SERVICE PARTS WILL BE AVAILABLE)

Page intentionally left blank for DVD743 EU PSU schematic when it is available

DVD723-743 30442-AV-Board: Video & Scart

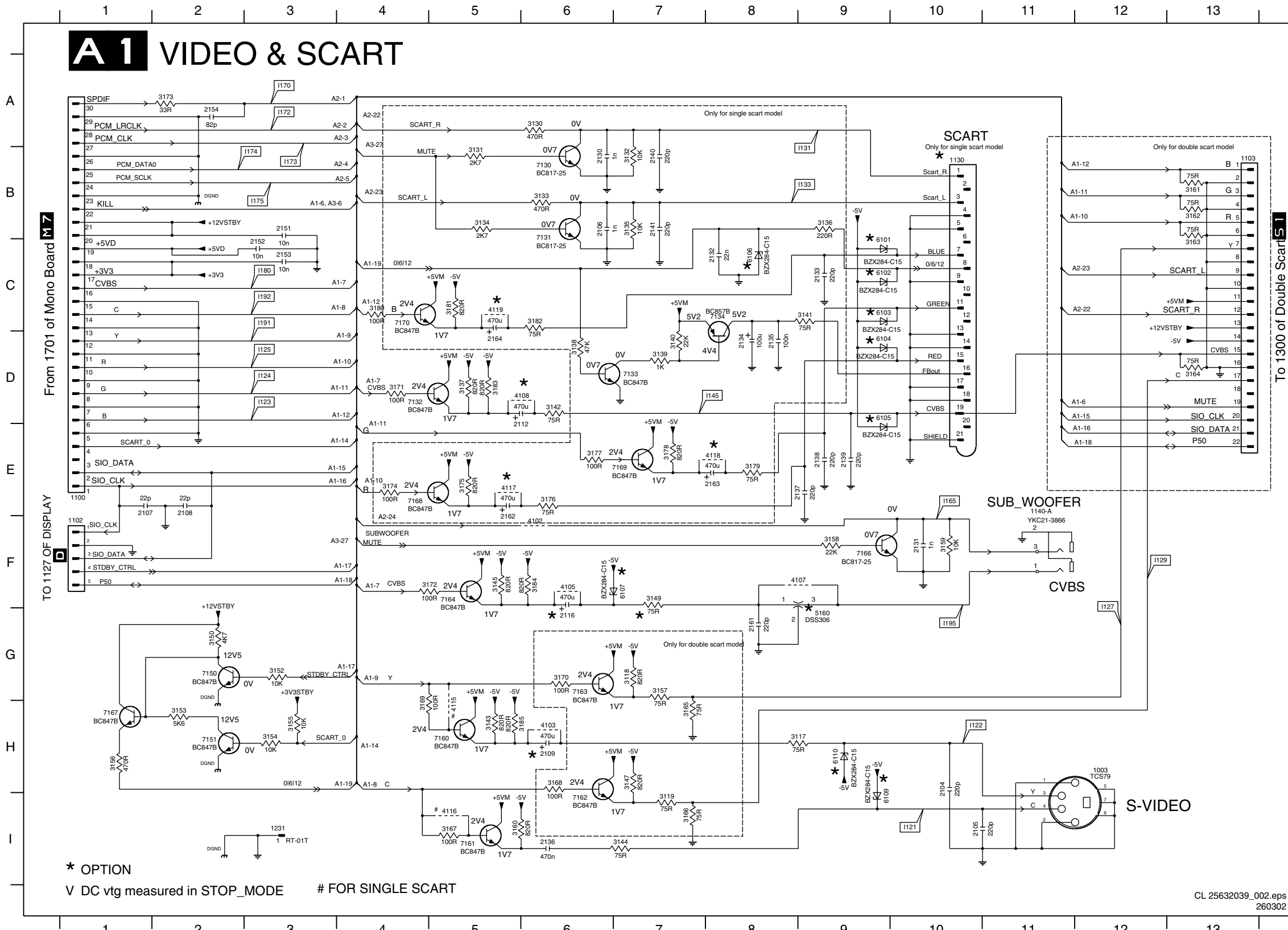

- 1003 H12
- 1100 E1
- 1102 F1
- 1103 B13
- 1130 B10
- 1140-A E11
- 1231 I3
- 2104 H10
- 2105 I10
- 2106 B6
- 2107 E1
- 2108 E2
- 2109 H6
- 2112 D6
- 2116 G6
- 2130 B6
- 2131 F10
- 2132 C8
- 2133 C9
- 2134 D8
- 2135 D8
- 2136 I6
- 2137 E9
- 2138 E9
- 2139 E9
- 2140 B7
- 2141 B7
- 2151 B3
- 2152 C3
- 2153 C3
- 2154 A2
- 2162 E5
- 2163 E8
- 2164 D5
- 2165 D5
- 2166 F9
- 2167 H1
- 2168 E4
- 2169 E6
- 2170 C4
- 7134 C8
- 7150 G2
- 7151 H2
- 7160 H5
- 7161 I5
- 7162 I6
- 7163 G6
- 7164 F5
- 7166 F9
- 7167 H1
- 7168 E4
- 7169 E6
- 7170 C4

DIVERSITY TABLE FOR DIAGRAM A1

ITEM NO	DESCRIPTION	DVD7230X1	DVD7430X1
1103	CON BM V 22P F 1.00 PFC 0.3 B	X	X
1130	SOC EURO H 21P F BK L-GRND B	X	X
2112	CER1 0603 NPO 25V 1N COL	X	X
2162 E5	ELCAP 16V S 470U PM20 COL A	X	X
2163 E8	CER2 0603 NPO 25V 22N COL	X	X
2164 D5	CER2 0603 X7R 16V 100N COL	X	X
2165 D5	CER1 0603 NPO 50V 220P COL	X	X
2166 F9	ELCAP 25V S 100U PM20 COL A	X	X
2167 H1	CER2 0603 X7R 16V 100N COL	X	X
2168 E4	CER1 0603 NPO 50V 220P COL	X	X
2169 E6	ELCAP 16V S 470U PM20 COL A	X	X
2170 C4	ELCAP 16V S 470U PM20 COL A	X	X
3136	RST SM 0603 220R PM5 COL	X	X
3137 E9	RST SM 0603 68R PM5 COL	X	X
3138 E9	RST SM 0603 470R PM5 COL	X	X
3139 E9	RST SM 0603 2K7 PM5 COL	X	X
3140 B7	RST SM 0603 10K PM5 COL	X	X
3141 B7	RST SM 0603 560R PM5 COL	X	X
3142 D7	RST SM 0603 10K PM5 COL	X	X
3143 D7	RST SM 0603 220R PM5 COL	X	X
3144 I7	RST SM 0603 47K PM5 COL	X	X
3145 F5	RST SM 0603 1K PM5 COL	X	X
3146 F7	RST SM 0603 75R PM5 COL	X	X
3147 H7	RST SM 0603 75R PM5 COL	X	X
3148 F7	RST SM 0603 22K PM5 COL	X	X
3149 F7	RST SM 0603 68R PM5 COL	X	X
3150 G2	RST SM 0603 75R PM5 COL	X	X
3151 G2	RST SM 0603 75R PM5 COL	X	X
3152 G3	RST SM 0603 75R PM5 COL	X	X
3153 H2	RST SM 0603 75R PM5 COL	X	X
3154 H3	RST SM 0603 75R PM5 COL	X	X
3155 H3	RST SM 0603 75R PM5 COL	X	X
3156 H1	RST SM 0603 75R PM5 COL	X	X
3157 G7	RST SM 0603 75R PM5 COL	X	X
3158 F9	RST SM 0603 100R PM5 COL	X	X
3159 F10	RST SM 0603 100R PM5 COL	X	X
3160 I5	RST SM 0603 100R PM5 COL	X	X
3161 B13	RST SM 0603 100R PM5 COL	X	X
3162 B13	RST SM 0603 100R PM5 COL	X	X
3163 C13	RST SM 0603 820R PM5 COL	X	X
3164 D13	RST SM 0603 68R PM5 COL	X	X
3165 H7	RST SM 0603 100R PM5 COL	X	X
3166 I7	RST SM 0603 820R PM5 COL	X	X
3167 I5	RST SM 0603 820R PM5 COL	X	X
3168 H6	RST SM 0603 100R PM5 COL	X	X
3169 H4	RST SM 0603 100R PM5 COL	X	X
3170 G6	RST SM 0603 68R PM5 COL	X	X
3171 D4	RST SM 0603 820R PM5 COL	X	X
3172 F5	RST SM 0603 JUMP. 0R05 COL	X	X
3173 A2	RST SM 0603 JUMP. 0R05 COL	X	X
3174 E4	RST SM 0603 JUMP. 0R05 COL	X	X
3175 E5	TRA SIG SM BC817-25 (COL) R	X	X
3176 E6	TRA SIG SM BC847B (COL) R	X	X
3177 E6	TRA SIG SM BC847B (COL) R	X	X
3178 E7	TRA SIG SM BC847B (COL) R	X	X
3179 E8	TRA SIG SM BC847B (COL) R	X	X
3180 C4	TRA SIG SM BC847B (COL) R	X	X
3181 C5	TRA SIG SM BC847B (COL) R	X	X
3182 C6	TRA SIG SM BC847B (COL) R	X	X
3183 D5	TRA SIG SM BC847B (COL) R	X	X
3184 F6	TRA SIG SM BC847B (COL) R	X	X
3185 H5	TRA SIG SM BC847B (COL) R	X	X
4102 F6			
4103 H6			
4105 F6			
4107 F9			
4108 D6			
4115 H5			
4116 I5			
4117 E5			
4118 E8			
4119 C5			
5160 G9			
6101 C9			
6102 C9			
6103 C9			
6104 D9			
6105 D9			
6106 C8			
6107 F7			
6109 I9			
6110 H9			
7130 B6			
7131 C6			
7132 D4			
7133 D7			

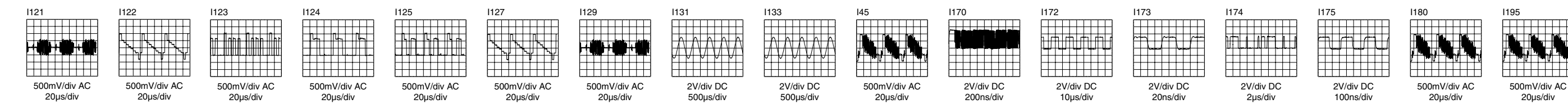

DVD723-743 30442-AV-Board: Audio

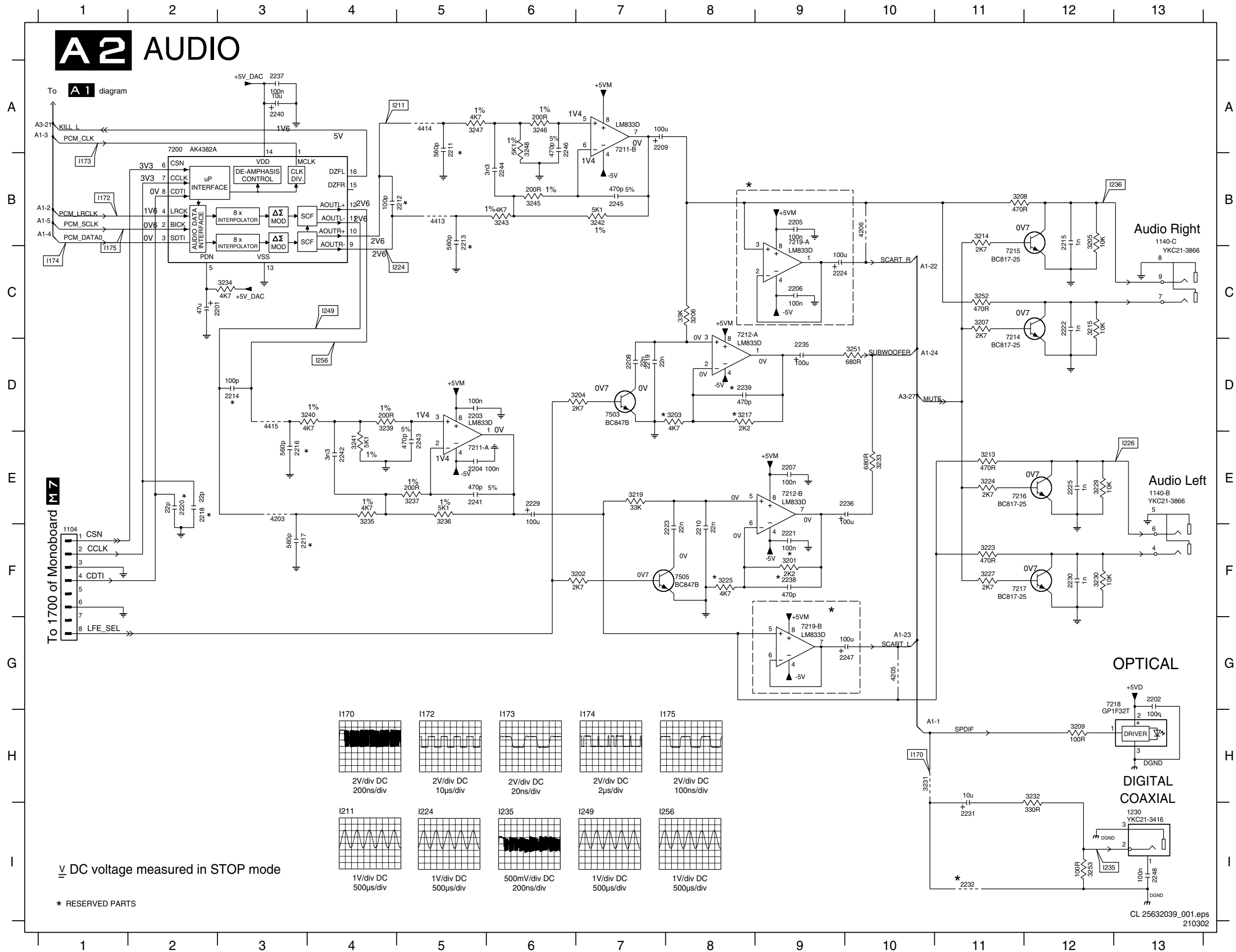

- 1104 F1
- 1140-B E13
- 1140-C B13
- 1230 I13
- 2201 C2
- 2202 G13
- 2203 D5
- 2204 E5
- 2205 B9
- 2206 C9
- 2207 E9
- 2208 D7
- 2209 A7
- 2210 F8
- 2211 A5
- 2212 B5
- 2213 B5
- 2214 D3
- 2215 B12
- 2216 E3
- 2217 F3
- 2218 E2
- 2219 D7
- 2220 E2
- 2221 F9
- 2222 C12
- 2223 F8
- 2224 C9
- 2225 E12
- 2229 E6
- 2230 F12
- 2231 I11
- 2232 I11
- 2235 D9
- 2236 E10
- 2237 A3
- 2238 F9
- 2239 D8
- 2240 A3
- 2241 E5
- 2242 E4
- 2243 E5
- 2244 B6
- 2245 B7
- 2246 A6
- 2247 G10
- 2248 I13
- 3201 F9
- 3202 F7
- 3203 D8
- 3204 D7
- 3205 B12
- 3206 C8
- 3207 C11
- 3208 B11
- 3209 H12
- 3213 B11
- 3214 B11
- 3215 C12
- 3217 D8
- 3219 E7
- 3223 F11
- 3224 E11
- 3225 F8
- 3227 F11
- 3229 E12
- 3230 F12
- 3231 I10
- 3232 I12
- 3233 E10
- 3234 C3
- 3235 E4
- 3236 E5
- 3237 E5
- 3239 D4
- 3240 D4
- 3241 E4
- 3242 B7
- 3243 B6
- 3245 B6
- 3246 A6
- 3247 A5
- 3248 A6
- 3251 D10
- 3252 C11
- 3253 I12
- 4203 E3
- 4205 G10
- 4206 B10
- 4413 B5
- 4414 A5
- 4415 D3
- 7200 A2
- 7211-A E5
- 7211-B A7
- 7212-A C8
- 7212-B E9
- 7214 C11
- 7215 C11
- 7216 E12
- 7217 F12
- 7218 G12
- 7219-A B9
- 7219-B G9
- 7503 D7
- 7505 F8

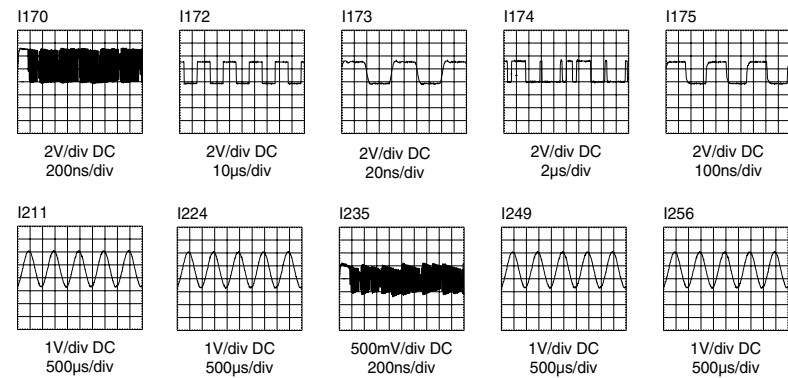

⊖ DC voltage measured in STOP mode

* RESERVED PARTS

DVD723-743 30442-AV-Board: Regulated Supply

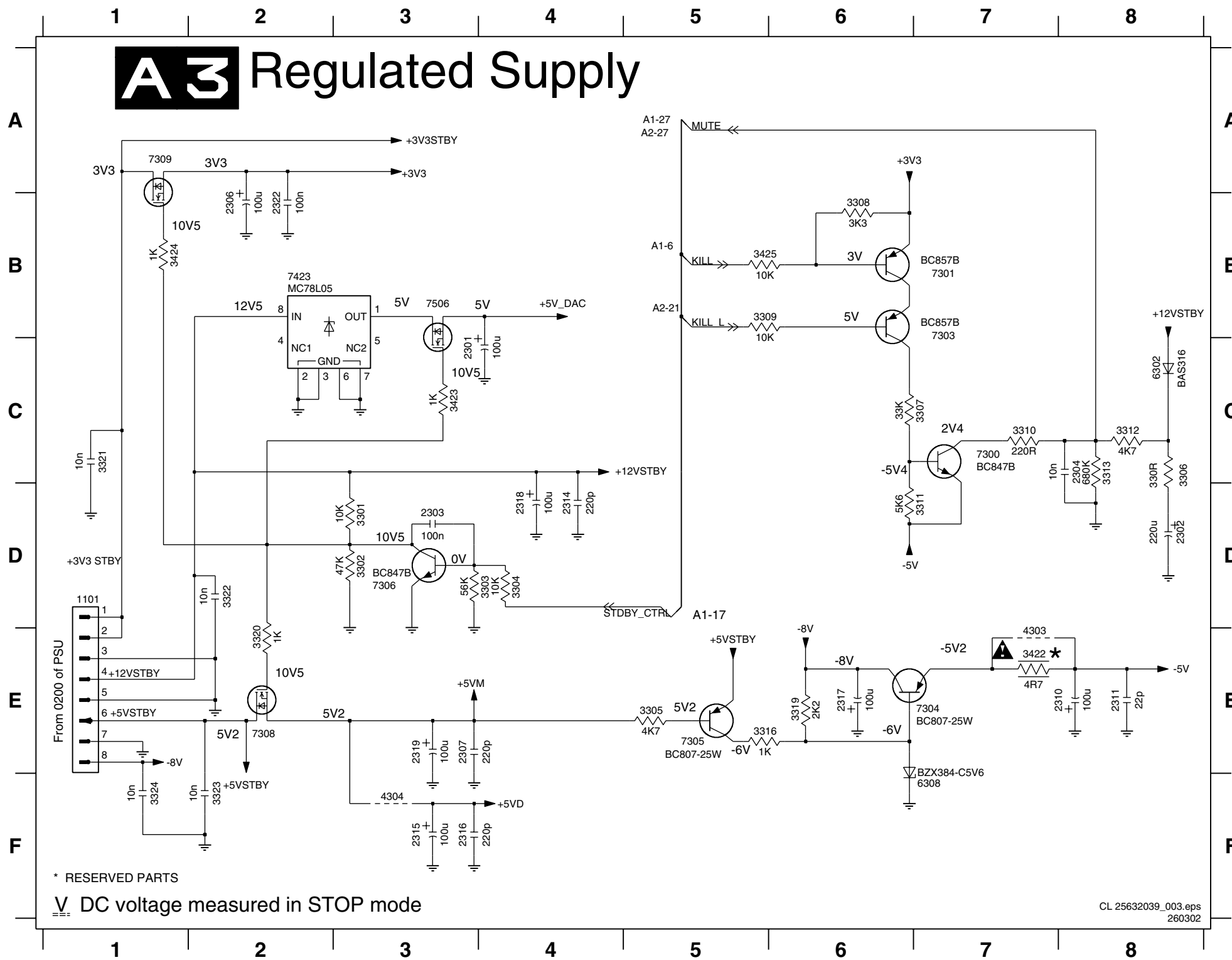

- 1101 D1
- 2301 C3
- 2302 D8
- 2303 D3
- 2304 C8
- 2306 B2
- 2307 E3
- 2310 E8
- 2311 E8
- 2314 D4
- 2315 F3
- 2316 F3
- 2317 E6
- 2318 D4
- 2319 E3
- 2322 B2
- 3301 D3
- 3302 D3
- 3303 D4
- 3304 D4
- 3305 E5
- 3306 C8
- 3307 C7
- 3308 B6
- 3309 B5
- 3310 C7
- 3311 D7
- 3312 C8
- 3313 C8
- 3316 E5
- 3319 E6
- 3320 E2
- 3321 C1
- 3322 D2
- 3323 F2
- 3324 F1
- 3422 E7
- 3423 C3
- 3424 B1
- 3425 B5
- 4303 E7
- 4304 F3
- 6302 C8
- 6308 F7
- 7300 C7
- 7301 B7
- 7303 B7
- 7304 E7
- 7305 E5
- 7306 D3
- 7308 E2
- 7309 A1
- 7423 B2
- 7506 B3

Layout DVD723-743 30442-AV-Board (Top View)

1003	B5	1140	B3	2162	B6	2231	B1	2306	A3	7218	B2	9707	A1	9714	B1	9724	A3	9731	A4	9738	B5	9745	A6	9752	B6	9761	A7	9768	B2
1100	A2	1230	B1	2163	A6	2235	A4	2310	B7	9701	B1	9708	A2	9715	B1	9725	A3	9732	A4	9739	A5	9746	A6	9753	B6	9762	A7	9769	A7
1101	A5	1231	A3	2164	A6	2236	A4	2315	A5	9702	A1	9709	A2	9718	A3	9726	A3	9733	A4	9740	A5	9747	A6	9754	B6	9763	A7	9770	A3
1102	A1	2109	B5	2201	B1	2240	B1	2317	A4	9703	A1	9710	A1	9719	A2	9727	B3	9734	A4	9741	B5	9748	A6	9756	B6	9764	A7		
1103	A6	2112	B6	2209	A2	2247	A7	2318	A5	9704	A2	9711	A2	9720	A2	9728	B3	9735	A4	9742	B5	9749	A1	9757	B6	9765	A7		
1104	A1	2116	B4	2224	A7	2301	B1	2319	A5	9705	A1	9712	A3	9722	A2	9729	B3	9736	A5	9743	A5	9750	A6	9758	B6	9766	A7		
1130	B6	2134	B5	2229	B2	2302	B3	5160	B4	9706	A2	9713	B1	9723	A3	9730	B3	9737	A5	9744	A6	9751	A6	9759	A6	9767	A7		

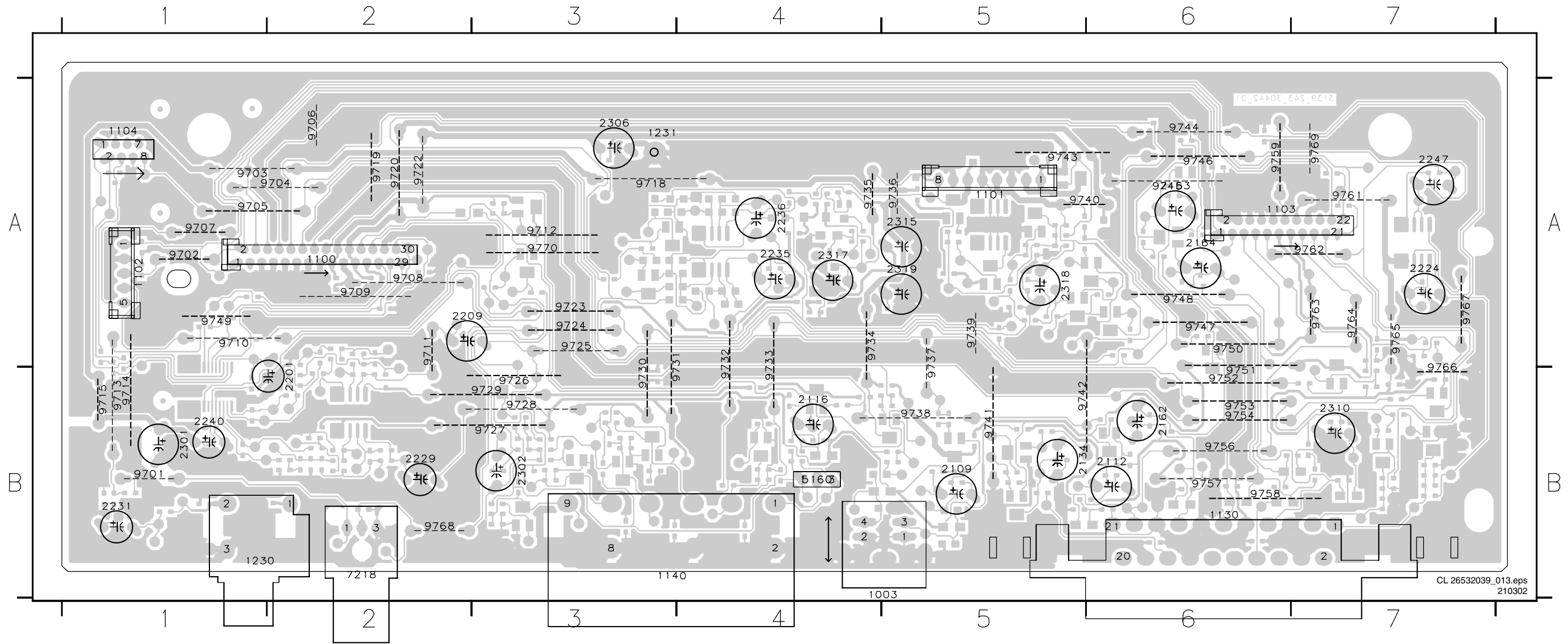

Layout DVD723-743 30442-AV-Board (Bottom View)

2104 B3	2161 B4	2222 B5	2316 A4	3145 B4	3168 B1	3203 A4	3233 A4	3304 A3	3425 A5	4802 A7	4829 A4	6102 B2	7163 B1	7306 A3
2105 B3	2202 B6	2223 A5	2322 A5	3147 B1	3169 B3	3204 A5	3234 B7	3305 A4	4102 B4	4803 A7	4830 A3	6103 B2	7164 B4	7308 A3
2106 B1	2203 B6	2225 B5	3117 B3	3149 B4	3170 B1	3205 B5	3235 B6	3306 B5	4103 B3	4804 A7	4832 A2	6104 B2	7166 B4	7309 A3
2107 A7	2204 B6	2230 B5	3118 B1	3150 A3	3171 B2	3206 A5	3236 B6	3307 A5	4105 B4	4805 A7	4833 B2	6105 B3	7167 A2	7423 A3
2108 A7	2205 A1	2232 B7	3119 A1	3152 A3	3172 B4	3207 B5	3237 B6	3308 A5	4107 B4	4806 A7	4835 A1	6106 B1	7168 A2	7503 A5
2130 B1	2206 B1	2237 B7	3130 B1	3153 A2	3173 A6	3208 B5	3239 B6	3309 A5	4108 B2	4809 B2	4836 A2	6107 B4	7169 A2	7505 A5
2131 B4	2207 A4	2238 A4	3131 B1	3154 A3	3174 A2	3209 B7	3240 B6	3310 B5	4115 B3	4810 A7	4837 B5	6109 B3	7170 A2	7506 A3
2132 B1	2208 A5	2239 A4	3132 B1	3155 A3	3175 B2	3213 B5	3241 B6	3311 B5	4116 B3	4811 B7	4838 A2	6110 B3	7200 B7	
2133 B1	2210 A4	2241 B6	3133 B1	3156 A2	3176 B2	3214 B5	3242 B6	3312 B5	4117 B2	4814 A7	4840 A2	6302 A6	7211 B6	
2135 B3	2211 A6	2242 B6	3134 B1	3157 B1	3177 A2	3215 B5	3243 B6	3313 B5	4118 A2	4815 A6	4841 A4	6308 A4	7212 A4	
2136 B3	2212 B7	2243 B6	3135 B1	3158 B4	3178 A2	3217 A4	3245 A6	3316 A4	4119 A2	4817 B5	4842 A4	7130 B1	7214 B5	
2137 B2	2213 B6	2244 A6	3136 B2	3159 B4	3179 A2	3219 A4	3246 A6	3319 A4	4203 B6	4819 A5	4843 B1	7131 B1	7215 B5	
2138 B2	2214 B7	2245 B6	3137 B2	3160 B3	3180 A2	3223 B5	3247 A6	3320 A3	4205 A1	4820 A4	4844 A3	7132 B2	7216 B5	
2139 B3	2215 B5	2246 B6	3138 B3	3161 A2	3181 A2	3224 B5	3248 A6	3321 A3	4206 A1	4821 A4	4846 B3	7133 B3	7217 B5	
2140 B1	2216 B6	2248 B6	3139 B3	3162 A2	3182 A2	3225 A5	3251 A4	3322 A2	4303 A4	4822 B5	4847 B3	7134 B3	7219 A1	
2141 B1	2217 B6	2303 A3	3140 B3	3163 A2	3183 B2	3227 B5	3252 B5	3323 A3	4304 A3	4823 B5	4848 B3	7150 A3	7300 B5	
2151 A6	2218 A7	2304 B5	3141 B3	3164 B2	3184 B4	3229 B5	3253 B7	3324 A3	4413 B6	4824 B5	4849 B4	7151 A2	7301 A5	
2152 A6	2219 A5	2307 A3	3142 B3	3165 A1	3185 B3	3230 B5	3301 A3	3422 A4	4414 A6	4825 B4	4850 B4	7160 B3	7303 A5	
2153 A6	2220 A7	2311 B1	3143 B3	3166 A1	3201 A4	3231 B7	3302 A3	3423 A3	4415 B6	4827 A3	4851 B1	7161 B3	7304 A4	
2154 A6	2221 A5	2314 A3	3144 B4	3167 B3	3202 A5	3232 B7	3303 A3	3424 A3	4653 A1	4828 A3	6101 B1	7162 B1	7305 A4	

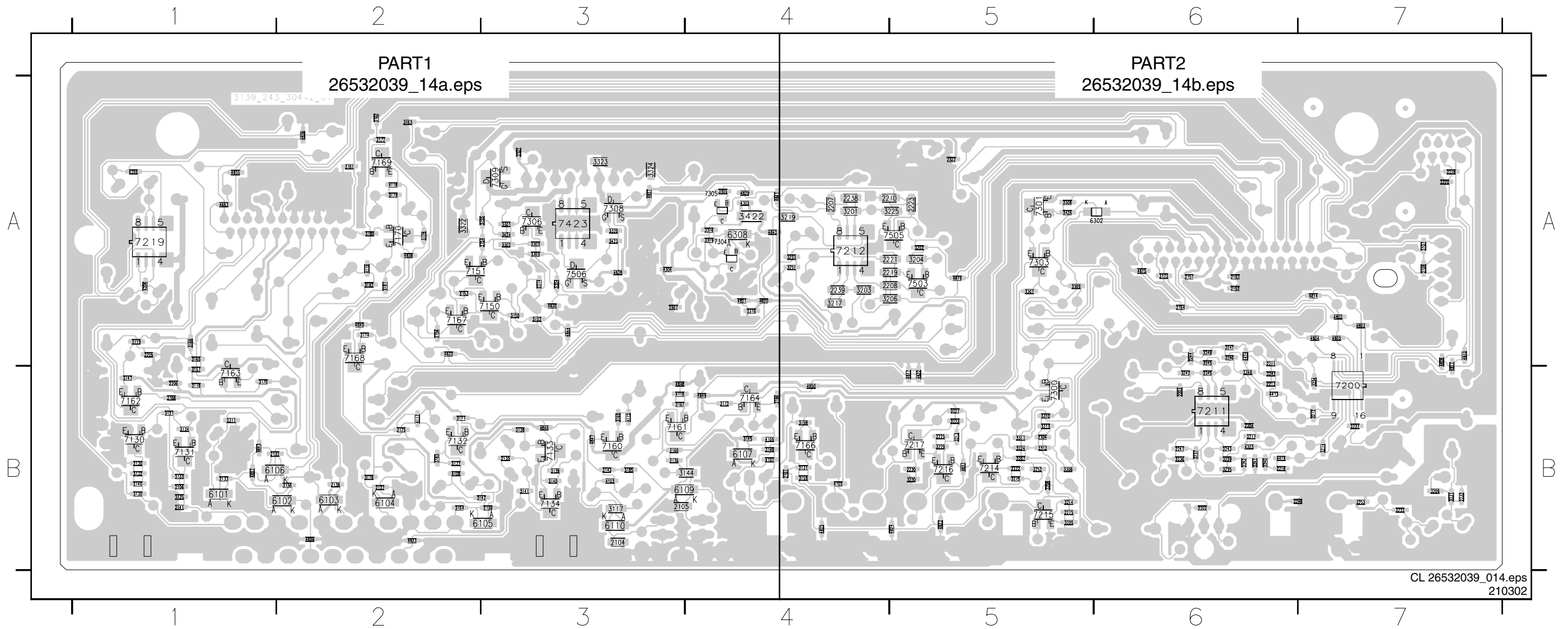

Layout DVD723-743 30442-AV-Board (Bottom View Part 1)

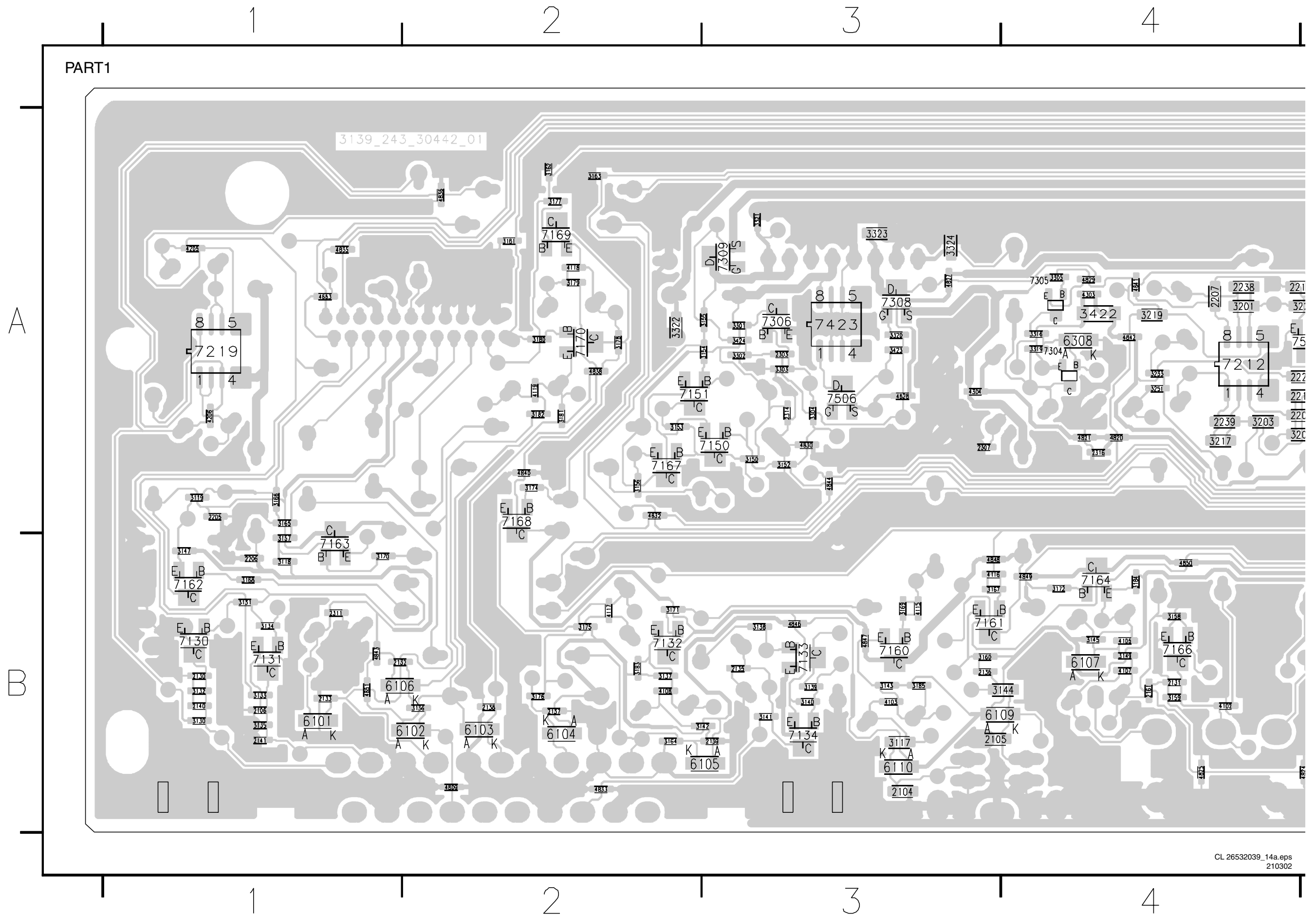

Layout DVD723-743 30442-AV-Board (Bottom View Part 2)

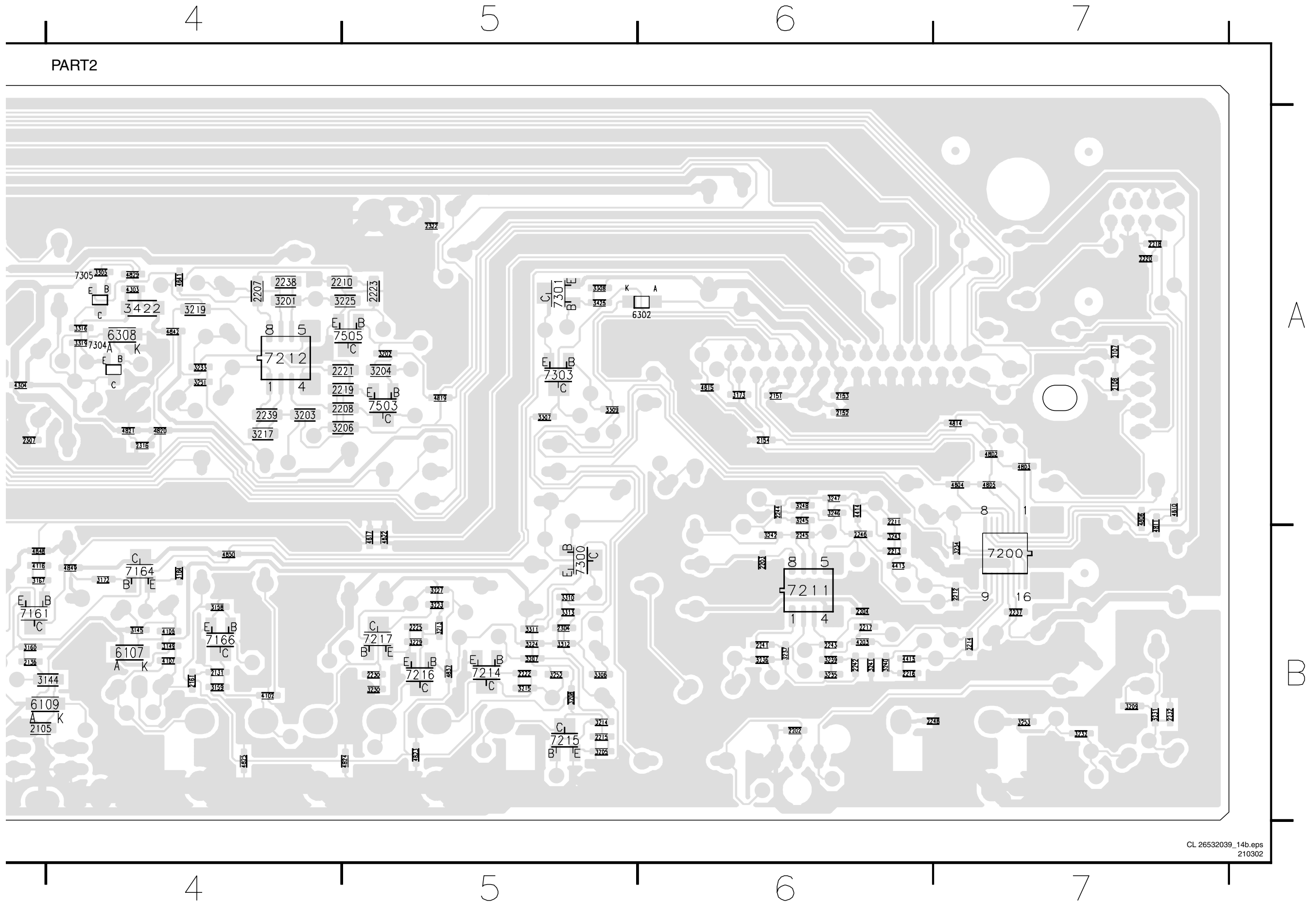

Layout DVD723-743 30442-Testpoint Overview

I101 B2	I125 A2	I139 B3	I154 B3	I176 B3	I195 B4	I211 B7	I224 B7	I237 A5	I251 A1	I315 A4	I331 B5
I102 B2	I126 B1	I140 A2	I155 B3	I177 A1	I196 A2	I212 B6	I225 B4	I238 B6	I256 B7	I316 A3	I332 A5
I103 B2	I127 A2	I141 B3	I156 A1	I178 B6	I200 A5	I213 A6	I226 B5	I240 B6	I300 A5	I317 B5	I333 A5
I104 A2	I128 B2	I142 B3	I157 A1	I179 A5	I201 A5	I214 A5	I227 B6	I241 A7	I301 A3	I318 A3	I334 A5
I105 A2	I129 A1	I143 B3	I158 B4	I180 B2	I202 A4	I215 B5	I228 A3	I242 A7	I302 A2	I319 A3	
I106 B2	I130 B1	I144 B3	I162 B4	I181 B1	I203 B6	I216 A4	I229 B5	I243 A7	I303 A3	I320 B5	
I107 A2	I131 B1	I145 B2	I165 B4	I187 A2	I204 A1	I217 A6	I230 B5	I244 A7	I304 A5	I321 B2	
I108 A2	I132 B1	I146 B1	I170 A6	I189 A1	I205 B5	I218 B6	I231 B7	I245 A4	I305 A5	I323 A4	
I109 A2	I133 B1	I148 A1	I171 B1	I190 A7	I206 B5	I219 A5	I232 B7	I246 A4	I306 A3	I324 B1	
I121 B4	I135 B2	I150 A3	I172 A6	I191 B3	I207 A6	I220 A4	I233 B7	I247 A4	I307 A3	I327 B3	
I122 B3	I136 B3	I151 A3	I173 A7	I192 B2	I208 B6	I221 B6	I234 B7	I248 A4	I308 A3	I328 A6	
I123 A7	I137 B3	I152 A3	I174 A7	I193 A1	I209 A6	I222 B6	I235 B7	I249 B7	I309 A3	I329 A4	
I124 A2	I138 B3	I153 A3	I175 A6	I194 B4	I210 A7	I223 B6	I236 B5	I250 A4	I312 B5	I330 B4	

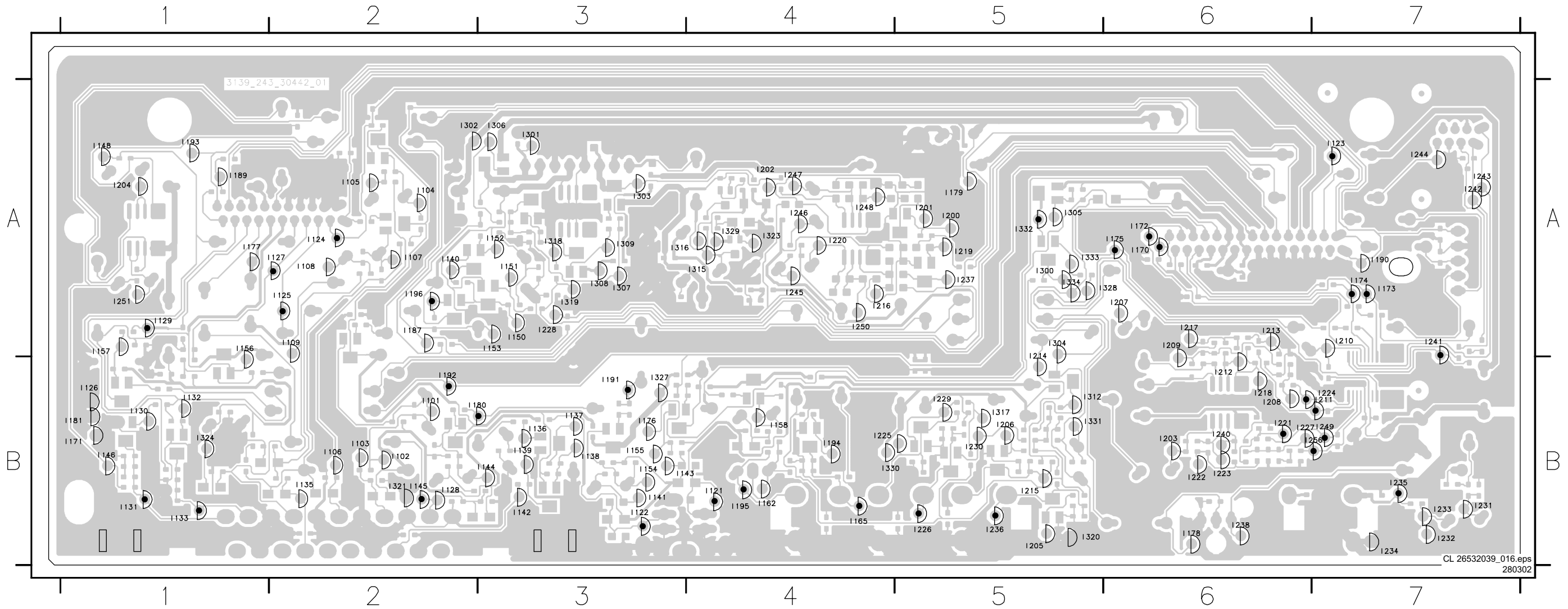

DVD723 30451-Front Board: Display Panel

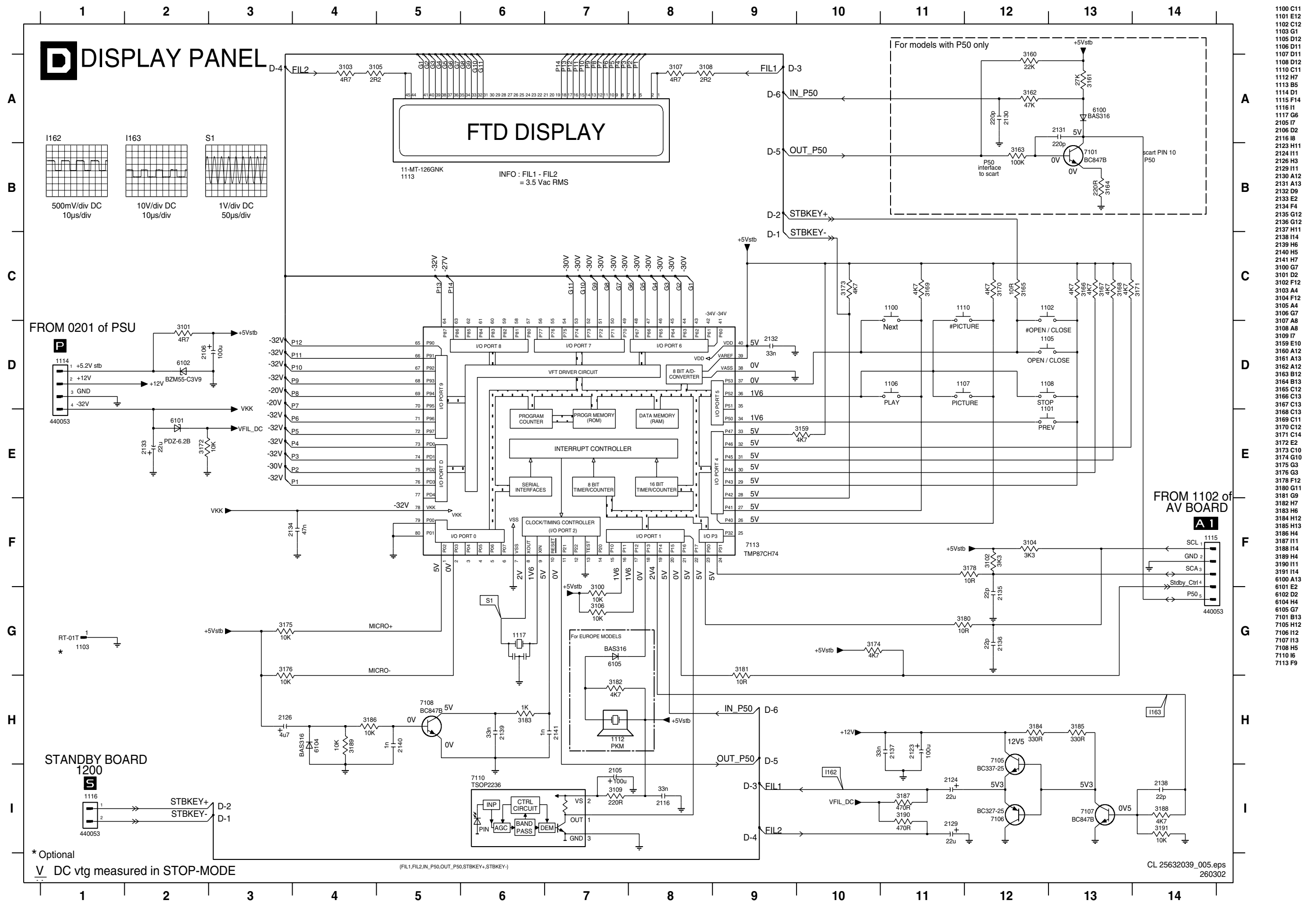

* Optional
V DC vtg measured in STOP-MODE

Layout DVD723 30451-Front Board (Top View)

1100 A2	1105 A8	1110 C21	1115 C3	2106 A9	2129 B1	7110 A11
1101 A3	1106 A6	1112 A10	1116 A22	2123 B2	2133 B22	
1102 C8	1107 A21	1113 B15	1117 C6	2124 C1	7105 B2	
1103 B22	1108 A5	1114 C22	2105 A7	2126 B3	7106 C2	

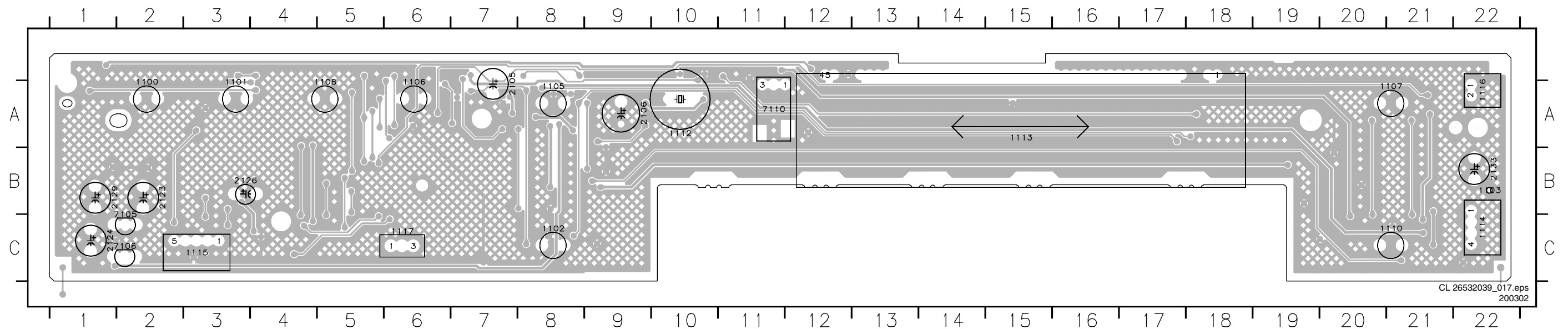

CL 26532039_017.eps
200302

Layout DVD723 30451-Front Board (Bottom View)

2116 A12	2136 C20	3100 C19	3106 C19	3161 A18	3167 A18	3173 A2	3181 B20	3187 C22	6101 B2	7108 B19
2130 C18	2137 B21	3101 B1	3107 A5	3162 C18	3168 A18	3174 C19	3182 A13	3188 B20	6102 C1	7113 B17
2131 A19	2138 B20	3102 B20	3108 A5	3163 C18	3169 A20	3175 C19	3183 C18	3189 B19	6104 B19	
2132 A17	2139 B18	3103 A11	3109 A16	3164 B20	3170 A18	3176 C19	3184 B21	3190 C22	6105 A13	
2134 C16	2140 B19	3104 B21	3159 A18	3165 A1	3171 A18	3178 B20	3185 A21	3191 B21	7101 A20	
2135 C20	2141 C18	3105 A11	3160 C19	3166 A18	3172 B1	3180 B20	3186 B19	6100 A20	7107 A21	

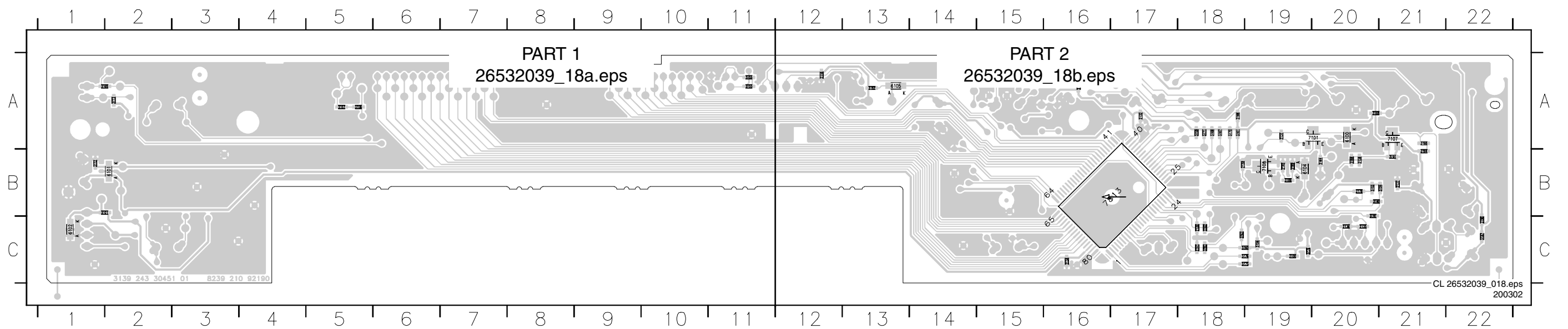

CL 26532039_018.eps
200302

Layout DVD723 30451-Front Board (Bottom View Part 1)

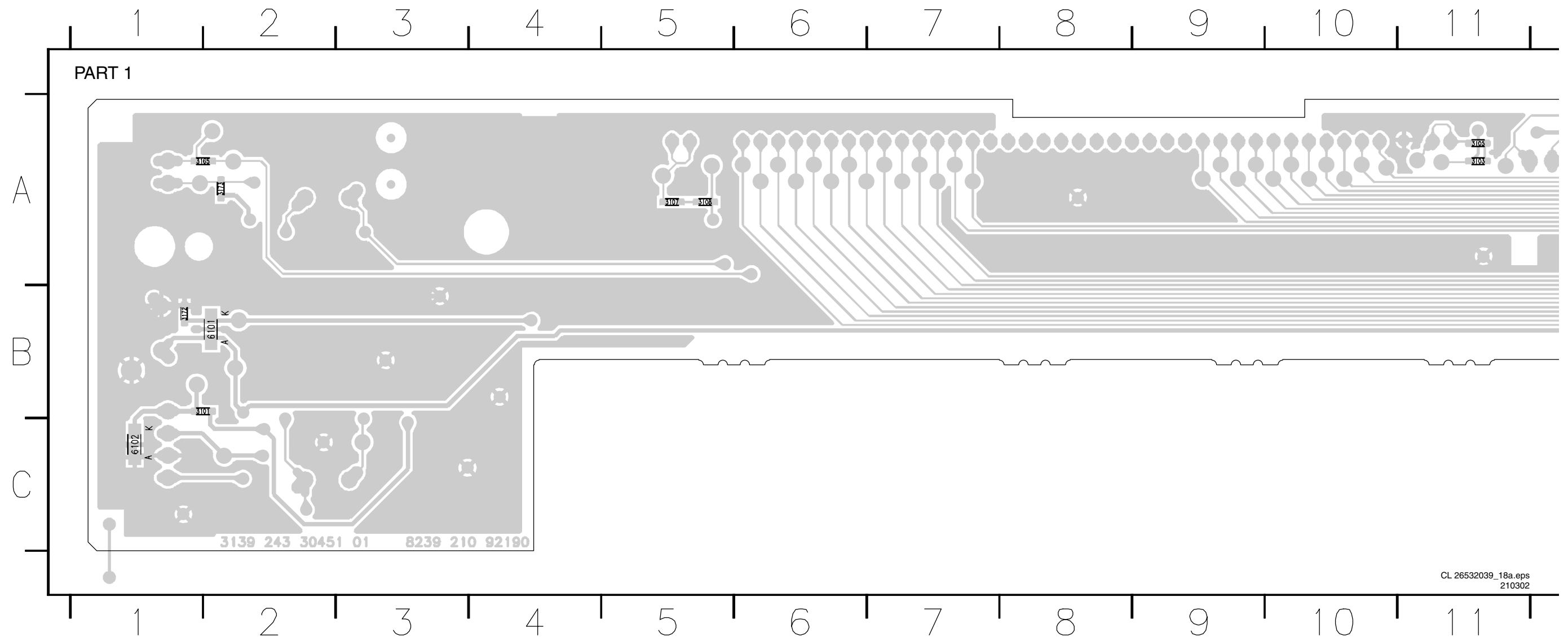

Layout DVD723 30451-Front Board (Bottom View Part 2)

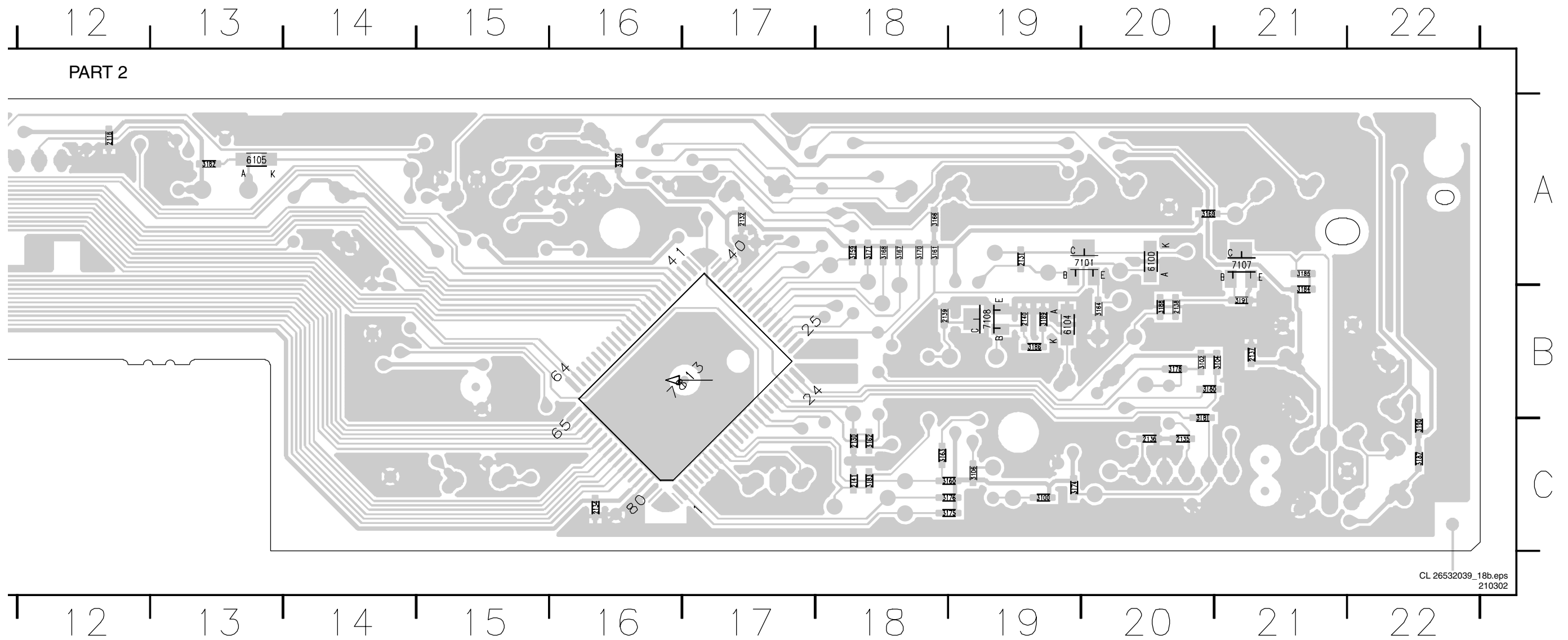

DVD743 30521-Front Board: Display Panel

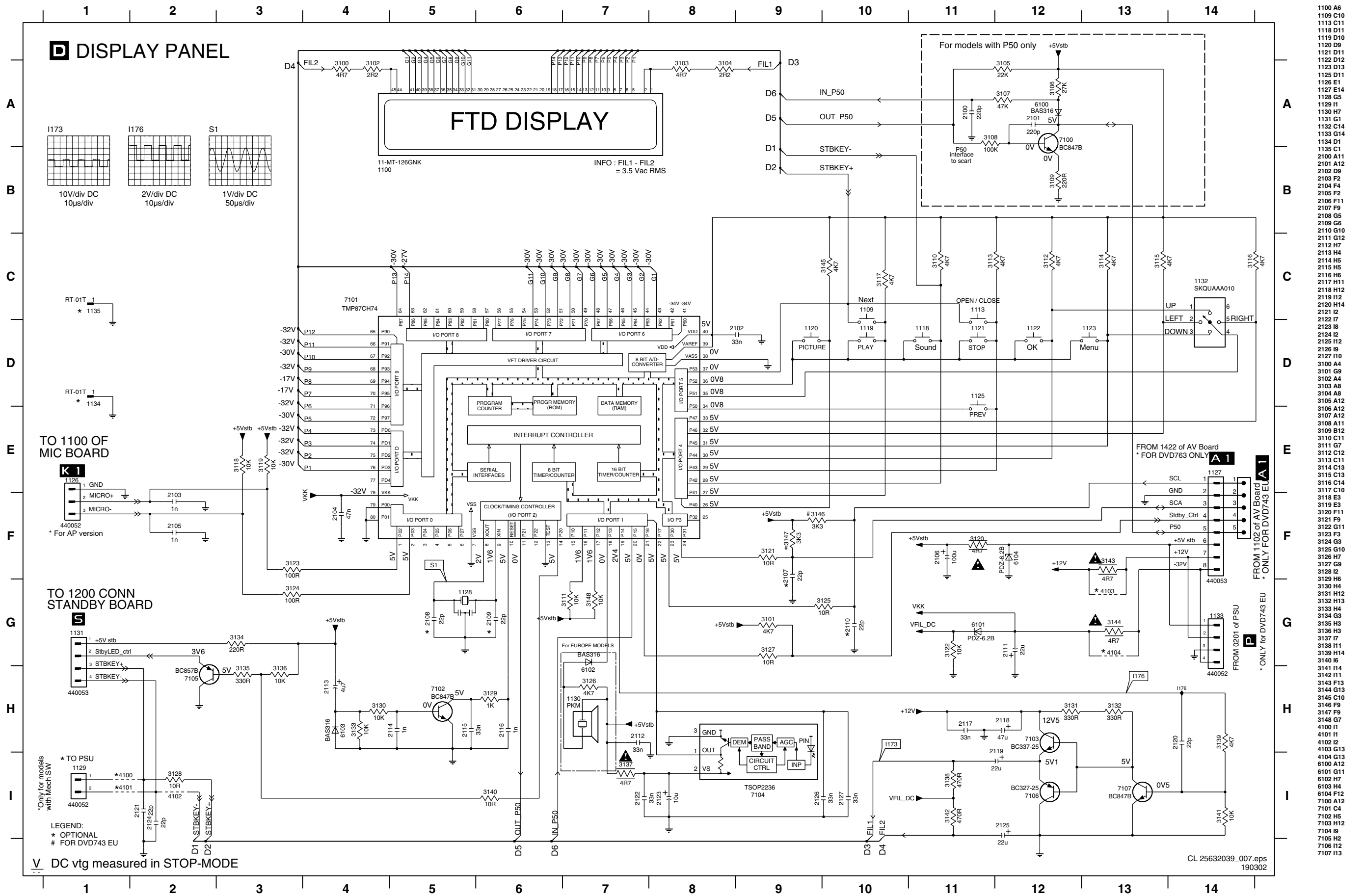

- 1100 A6
- 1109 C10
- 1113 C11
- 1118 D11
- 1119 D10
- 1120 D9
- 1121 D11
- 1122 D12
- 1123 D13
- 1125 D11
- 1126 E1
- 1127 E14
- 1128 G5
- 1129 H1
- 1130 H7
- 1131 G1
- 1132 C14
- 1133 G14
- 1134 D1
- 1135 C1
- 2100 A11
- 2101 A12
- 2102 D9
- 2103 F2
- 2104 F4
- 2105 F2
- 2106 F11
- 2107 F9
- 2108 G5
- 2109 G6
- 2110 G10
- 2111 G12
- 2112 H7
- 2113 H4
- 2114 H5
- 2115 H5
- 2116 H6
- 2117 H11
- 2118 H12
- 2119 H12
- 2120 H14
- 2121 I2
- 2122 I7
- 2123 H8
- 2124 I2
- 2125 I12
- 2126 I9
- 2127 I10
- 3100 A4
- 3101 G8
- 3102 A4
- 3103 A8
- 3104 A8
- 3105 A12
- 3106 A12
- 3107 A12
- 3108 A11
- 3109 B12
- 3110 C11
- 3111 G7
- 3112 C12
- 3113 C11
- 3114 C13
- 3115 C13
- 3116 C14
- 3117 C10
- 3118 E3
- 3119 E3
- 3120 F11
- 3121 F9
- 3122 G11
- 3123 F3
- 3124 G3
- 3125 G10
- 3126 H7
- 3127 G9
- 3128 I2
- 3129 H6
- 3130 H4
- 3131 H12
- 3132 H13
- 3133 H4
- 3134 G3
- 3135 H3
- 3136 H3
- 3137 I7
- 3138 I11
- 3139 H14
- 3140 I6
- 3141 I14
- 3142 I11
- 3143 F13
- 3144 G13
- 3145 C10
- 3146 F9
- 3147 F9
- 3148 G7
- 4100 I1
- 4101 I1
- 4102 I2
- 4103 G13
- 4104 G13
- 5100 A12
- 5101 G11
- 5102 H7
- 5103 H4
- 5104 F12
- 7100 A12
- 7101 C4
- 7102 H5
- 7103 H12
- 7104 I9
- 7105 H2
- 7106 H12
- 7107 H13

Layout DVD743 30521-Front Board (Top View)

1100 A15	1118 B20	1121 A5	1125 A7	1128 C3	1131 A21	1134 B20	2111 B19	2119 B6	7103 C5
1109 A6	1119 B5	1122 A1	1126 C19	1129 A19	1132 B2	1135 C2	2113 A6	2123 A8	7104 B11
1113 B7	1120 B22	1123 B1	1127 A9	1130 A18	1133 A20	2106 B20	2118 B6	2125 B7	7106 B4

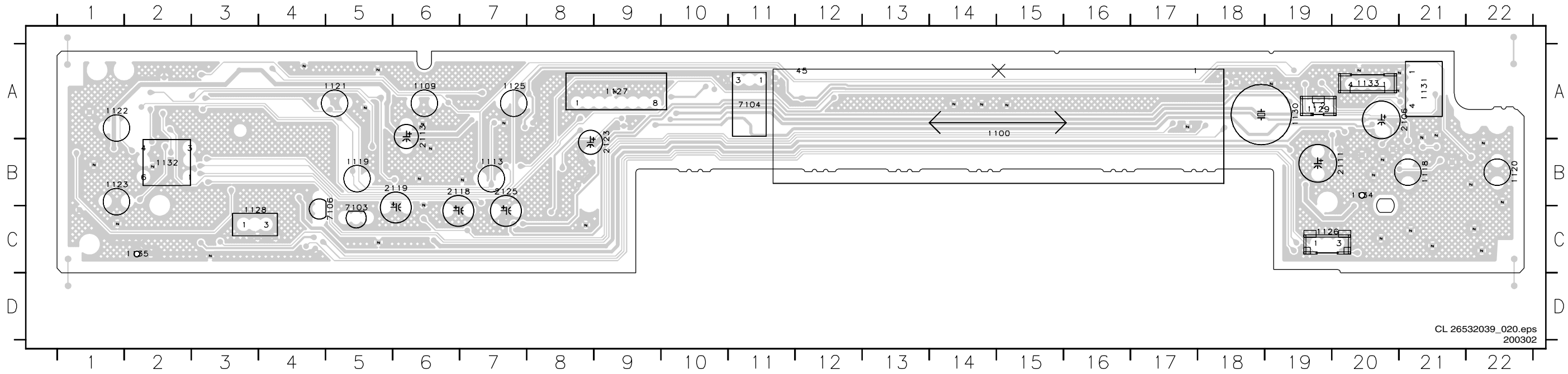

CL 26532039_020.eps
200302

Layout DVD743 30521-Front Board (Bottom View)

2100 C16	2107 A15	2115 A22	2124 A3	3103 A6	3109 B15	3115 B21	3121 A15	3127 A14	3133 A22	3139 C21	3145 C1	4102 A4	7101 A19
2101 B15	2108 C20	2116 B20	2126 A12	3104 A6	3110 B2	3116 B21	3122 A4	3128 A4	3134 A2	3140 B2	3146 A15	6100 B15	7102 A22
2102 A20	2109 C20	2117 C17	2127 A12	3105 C15	3111 C20	3117 A17	3123 C19	3129 A22	3135 B2	3141 C21	3147 A15	6101 B4	7105 B2
2103 C4	2110 A15	2120 B21	3100 A11	3106 C15	3112 B21	3118 C3	3124 C19	3130 A22	3136 C2	3142 C16	3148 B20	6102 B5	7107 C21
2104 C19	2112 A4	2121 A4	3101 A14	3107 B16	3113 A16	3119 C3	3125 A15	3131 C18	3137 A12	3143 A3	4100 A4	6103 A21	
2105 C4	2114 A22	2122 A13	3102 A11	3108 C15	3114 B21	3120 A2	3126 A5	3132 C18	3138 C16	3144 B3	4101 A4	7100 B15	

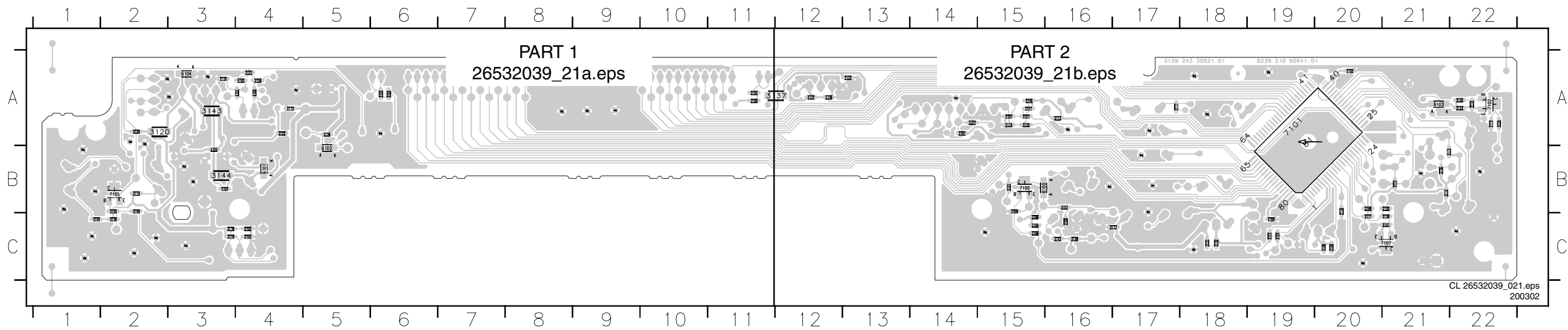

CL 26532039_021.eps
200302

Layout DVD743 30521-Front Board (Bottom View Part 1)

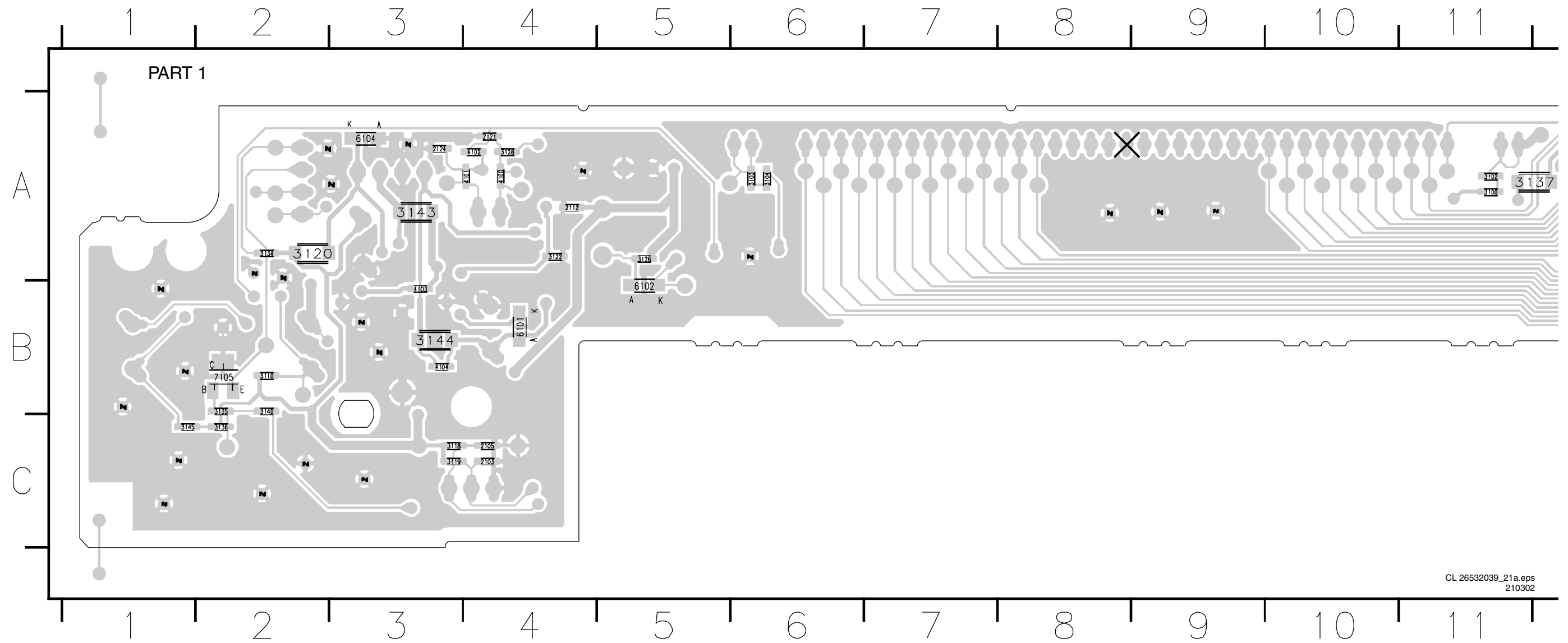

Layout DVD743 30521-Front Board (Bottom View Part 2)

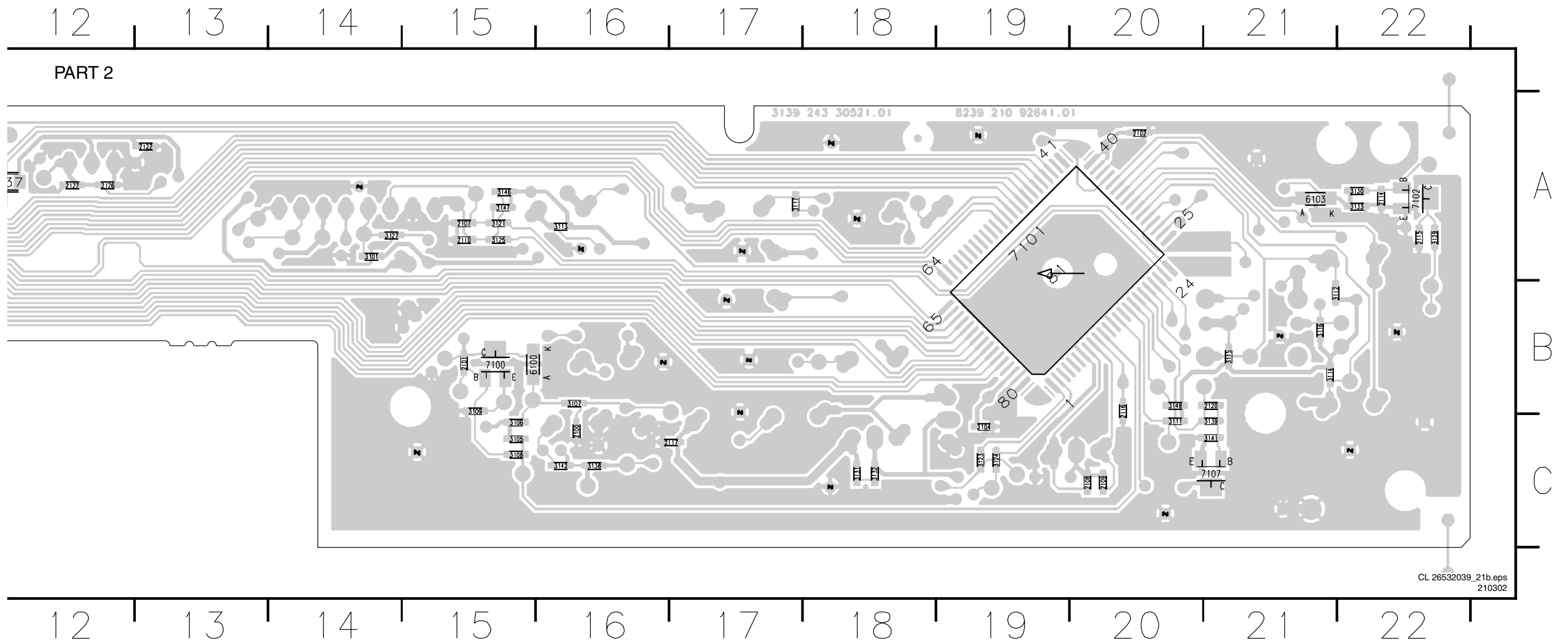

DVD743 30521-Front Board: Standby Panel

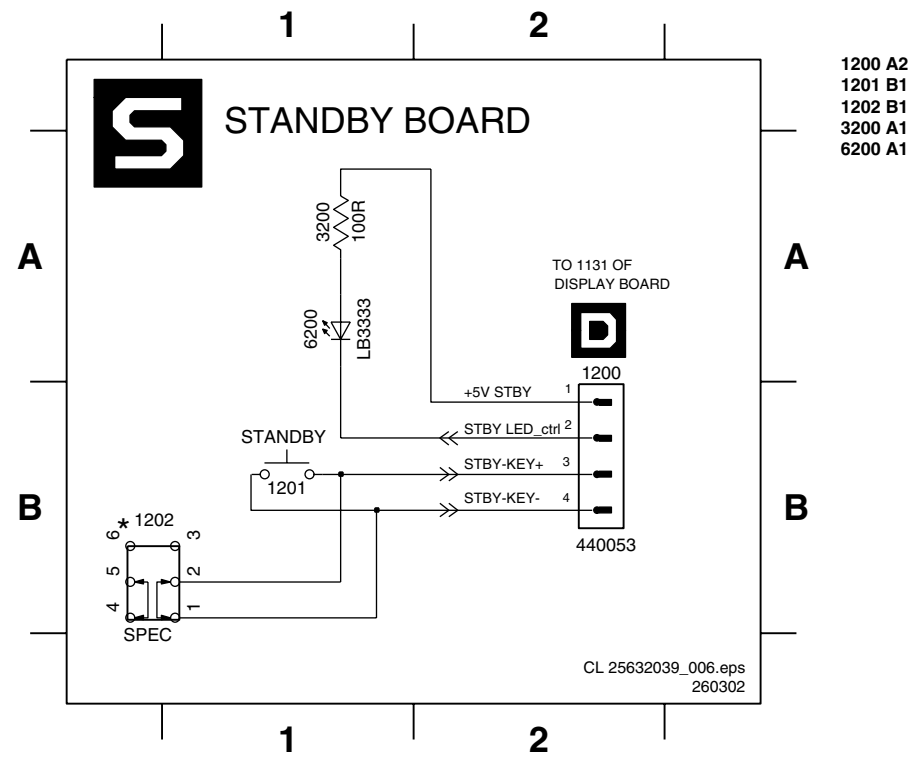

Layout DVD743 30521-Front Board: Standby Panel

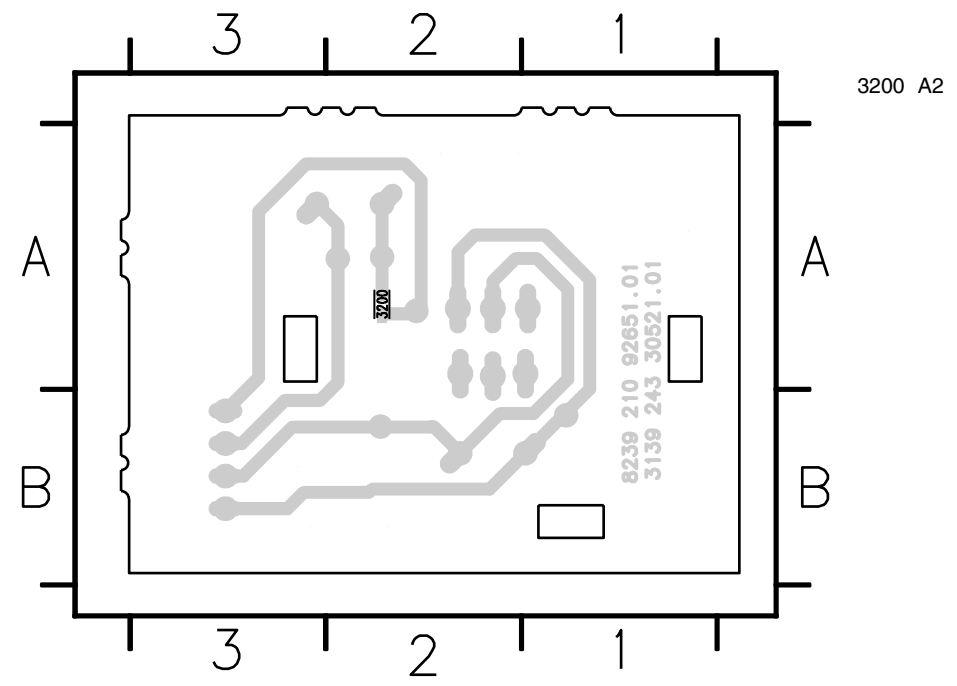
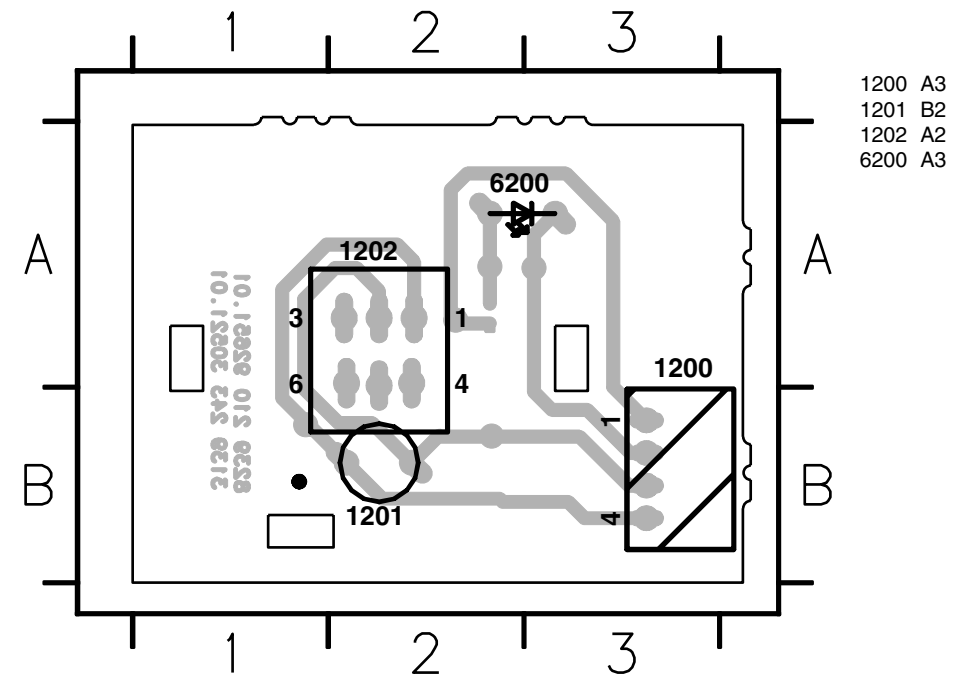

Switching Panel

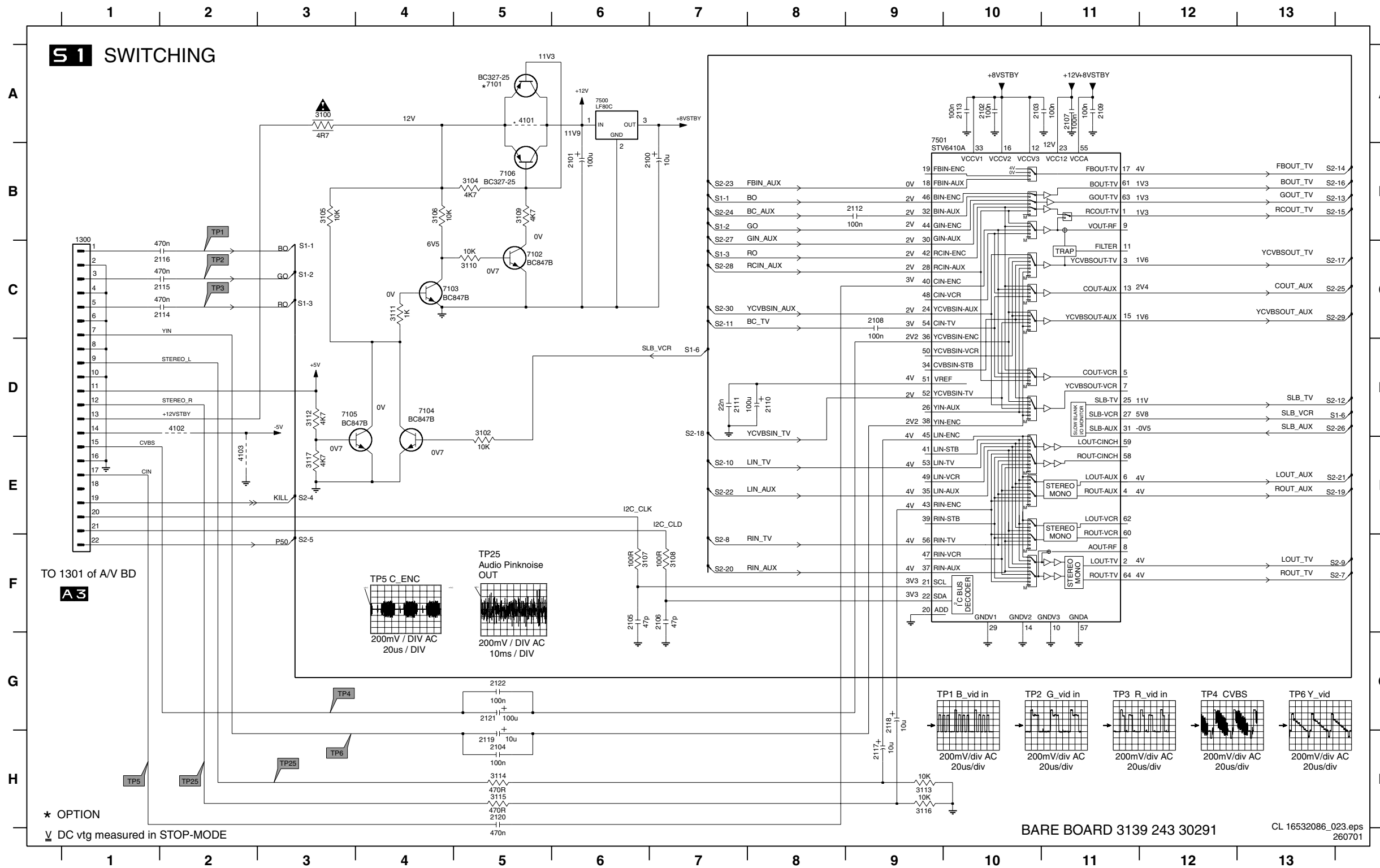

- 1300 C1
- 2100 B7
- 2101 B6
- 2102 A10
- 2103 A10
- 2104 H5
- 2105 F6
- 2106 F7
- 2107 A11
- 2108 C9
- 2109 A11
- 2110 D8
- 2111 D7
- 2112 B9
- 2113 A10
- 2114 C2
- 2115 C2
- 2116 C2
- 2117 H9
- 2118 G9
- 2119 H5
- 2120 H5
- 2121 G5
- 2122 G5
- 3100 A3
- 3102 D5
- 3104 B5
- 3105 B3
- 3106 B4
- 3107 F6
- 3108 F7
- 3109 B5
- 3110 C5
- 3111 C4
- 3112 D3
- 3113 H9
- 3114 H5
- 3115 H5
- 3116 H9
- 3117 E3
- 4101 A5
- 4102 D2
- 4103 E2
- 7101 A5
- 7102 C5
- 7103 C4
- 7104 D4
- 7105 D3
- 7106 B5
- 7500 A6
- 7501 B9

SCART Panel

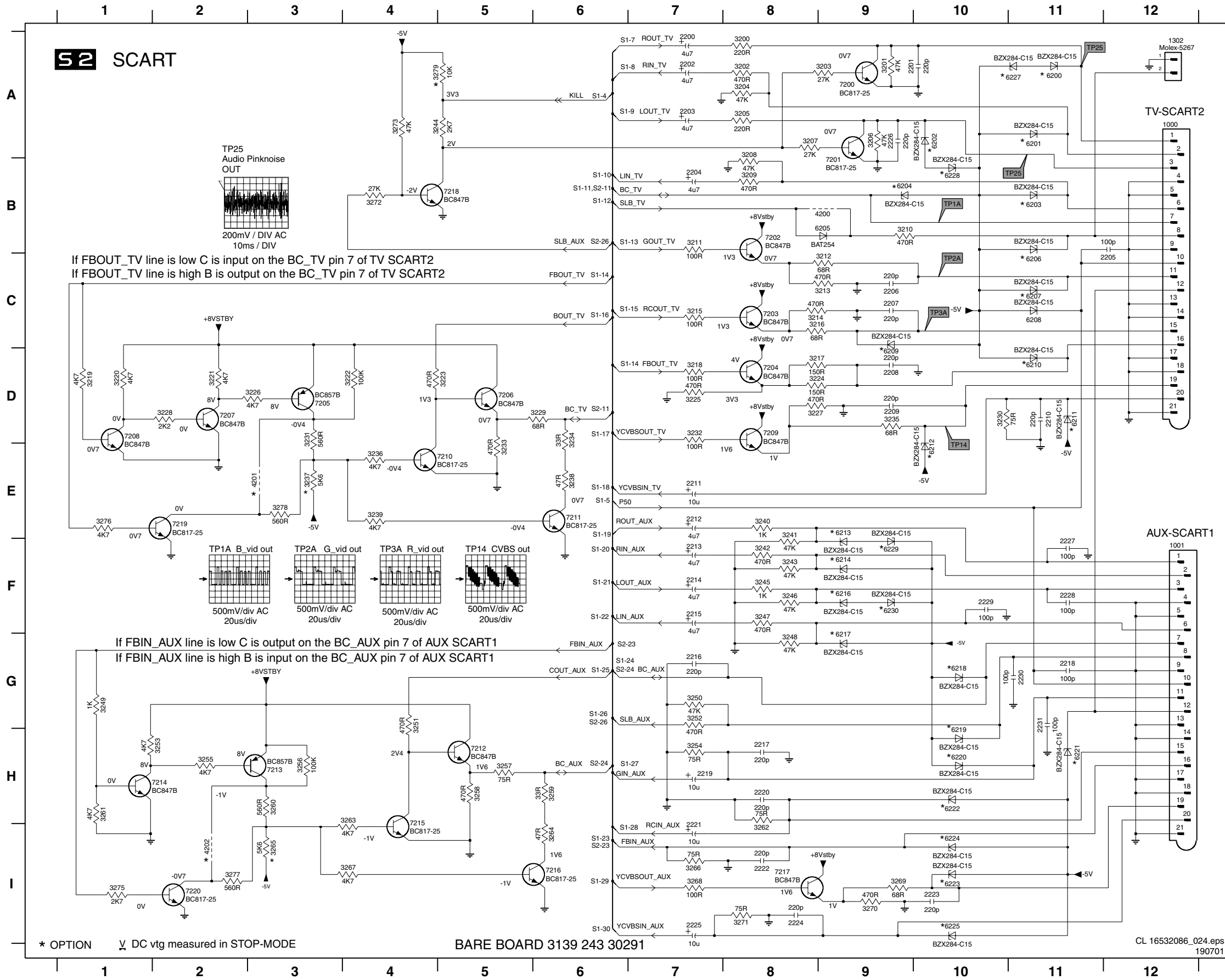

- 1000 A12
- 1001 F12
- 1302 A12
- 2200 A7
- 2201 A9
- 2202 A7
- 2203 A7
- 2204 B7
- 2205 C12
- 2206 C9
- 2207 C9
- 2208 D9
- 2209 D9
- 2210 D11
- 2211 E7
- 2212 E7
- 2213 F7
- 2214 F7
- 2215 F7
- 2216 G7
- 2217 H8
- 2218 G11
- 2219 H7
- 2220 H8
- 2221 I7
- 2222 I8
- 2223 I10
- 2224 I8
- 2225 I7
- 2226 A9
- 2227 F11
- 2228 F11
- 2229 F10
- 2230 G11
- 2231 G11
- 3200 A8
- 3201 A9
- 3202 A8
- 3203 A9
- 3204 A8
- 3205 A8
- 3206 A9
- 3207 A8
- 3208 A8
- 3209 B9
- 3210 B9
- 3211 B7
- 3212 C9
- 3213 C9
- 3214 C8
- 3215 C7
- 3216 C8
- 3217 D8
- 3218 D7
- 3219 D1
- 3220 D1
- 3221 D2
- 3222 D4
- 3223 D5
- 3224 D8
- 3225 D7
- 3226 D3
- 3227 D8
- 3228 D2
- 3229 D6
- 3230 D10
- 3231 D3
- 3232 D7
- 3233 E5
- 3234 D6
- 3235 D9
- 3236 E4
- 3237 E3
- 3238 E6
- 3239 E4
- 3240 E8
- 3241 E8
- 3242 F8
- 3243 F8
- 3244 A5
- 3245 F8
- 3246 F8
- 3247 F8
- 3248 G8
- 3249 G1
- 3250 G7
- 3251 G4
- 3252 G7
- 3253 H2
- 3254 H7
- 3255 H2
- 3256 H3
- 3257 H5
- 3258 H5
- 3259 H6
- 3260 H3
- 3261 H1
- 3262 H4
- 3263 H4
- 3264 I6
- 3265 I3
- 3266 I7
- 3267 I4
- 3268 I7
- 3269 I9
- 3270 I9
- 3271 I8
- 3272 B4
- 3273 A4
- 3274 I1
- 3275 E1
- 3277 I2
- 3278 E3
- 3279 A5
- 4200 B9
- 4201 E3
- 4202 I2
- 6200 A11
- 6201 A11
- 6202 A10
- 6203 B11
- 6204 B9
- 6205 B9
- 6206 C11
- 6207 C11
- 6208 C11
- 6209 D9
- 6210 D11
- 6211 D11
- 6212 E10
- 6213 E9
- 6214 F9
- 6215 F9
- 6216 G9
- 6217 G9
- 6218 G10
- 6219 H10
- 6220 H10
- 6221 H11
- 6222 H10
- 6223 I10
- 6224 I10
- 6225 I10
- 6226 I10
- 6227 A11
- 6228 B10
- 6229 F9
- 6230 F9
- 6231 A9
- 6232 B8
- 6233 C8
- 6234 D8
- 6235 D3
- 6236 D5
- 6237 D2
- 6238 D1
- 6239 D8
- 6240 A8
- 6241 E6
- 6242 H5
- 6243 H3
- 6244 H1
- 6245 I4
- 6246 I6
- 6247 I6
- 6248 I6
- 6249 B5
- 6250 E2
- 6251 I2

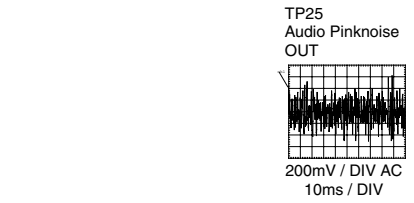

If FBOUT_TV line is low C is input on the BC_TV pin 7 of TV SCART2
 If FBOUT_TV line is high B is output on the BC_TV pin 7 of TV SCART2

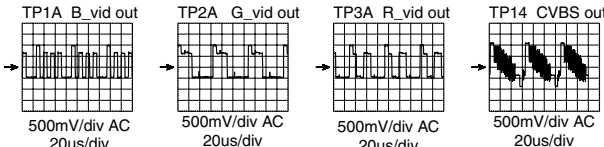

If FBIN_AUX line is low C is output on the BC_AUX pin 7 of AUX SCART1
 If FBIN_AUX line is high B is input on the BC_AUX pin 7 of AUX SCART1

* OPTION V DC vtg measured in STOP-MODE

Layout SCART Board (Top View Part 1)

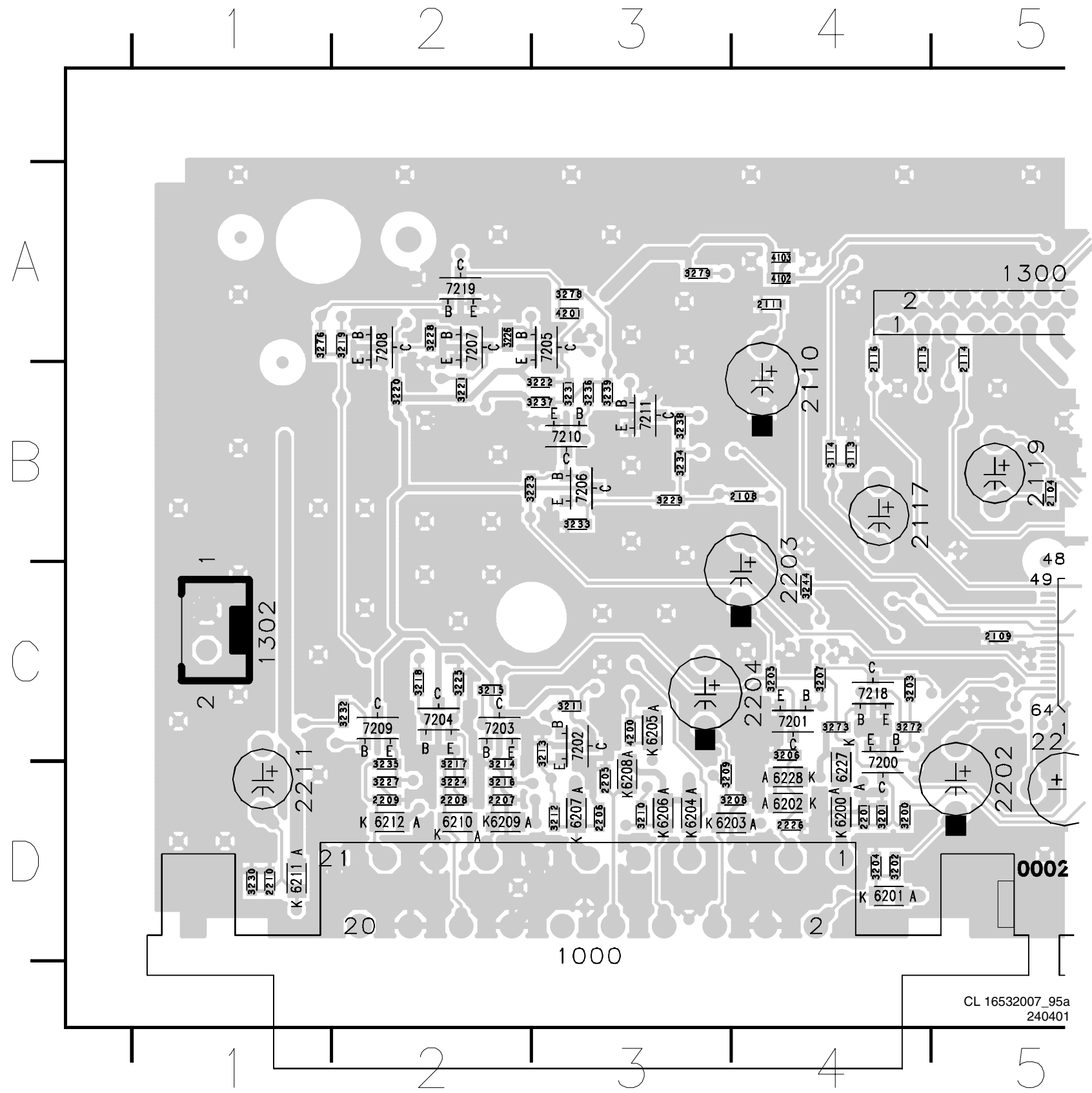

CL 16532007_95a
240401

Layout SCART Board (Top View Part 2)

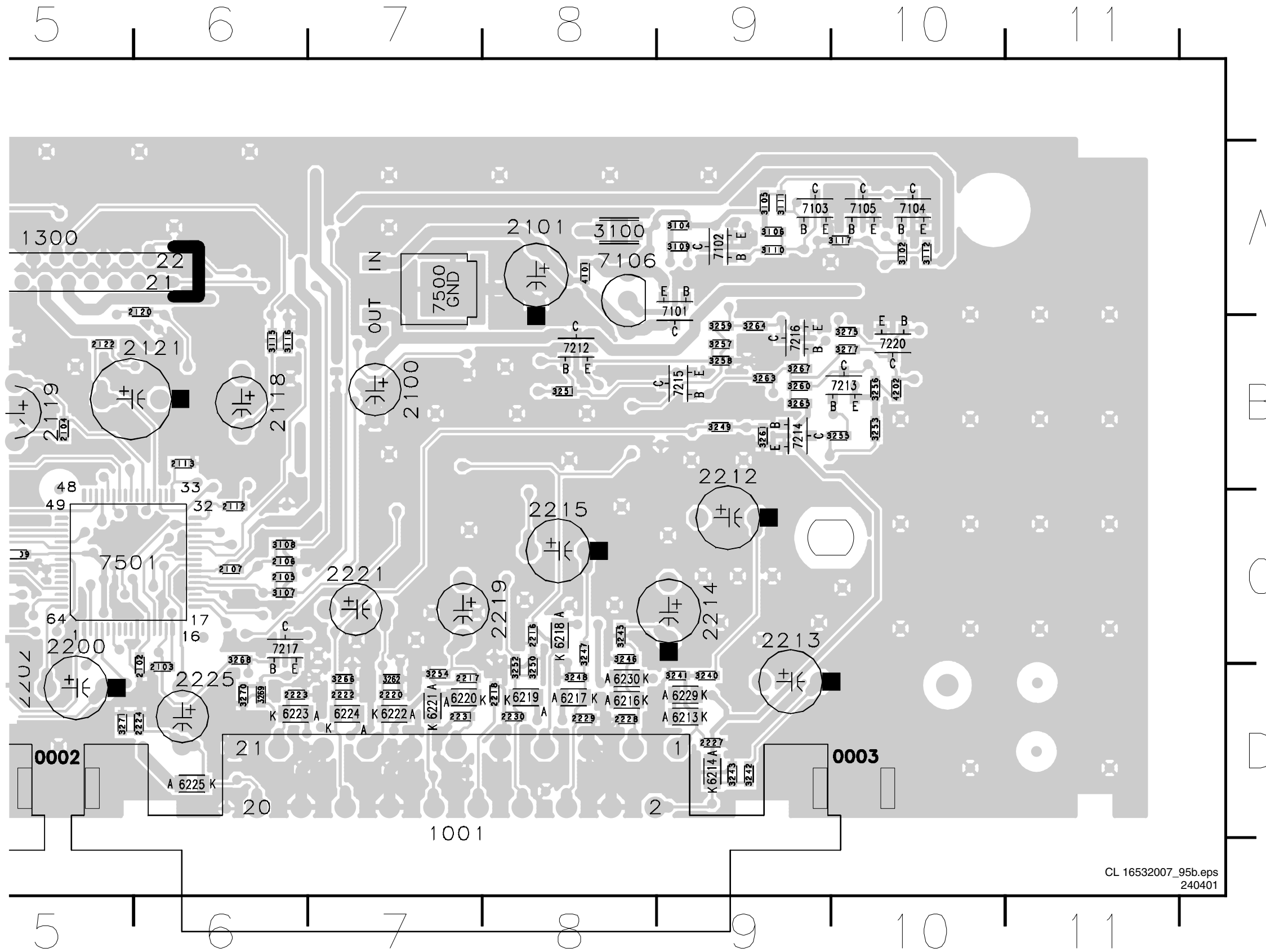

8. Alignments

Not applicable.

9. Circuit Descriptions, List of Abbreviations, and IC Data

Index of this chapter:

1. Introduction
2. Power Supply
3. Loader/Mono Board
4. Control and Display
5. Audio/Video (A/V) and SCART
6. Abbreviation list
7. IC Data

Notes:

- Figures can deviate slightly from the actual situation, due to different set executions.
- For a good understanding of the following circuit descriptions, please use the diagrams in chapter 6 and 7.

9.1 Introduction

The DVD7xx range (723, and 743) is a fourth generation DVD players. Some of their features are:

- MP3 playback.
- 3D Sound.
- Auto power off (after 15 min.).
- Build in MPEG2, MP3, and AC-3 decoder.
- CD-R(W) compatible.
- DVD+R(W) compatible.
- RGB video output on SCART.

Panel Overview

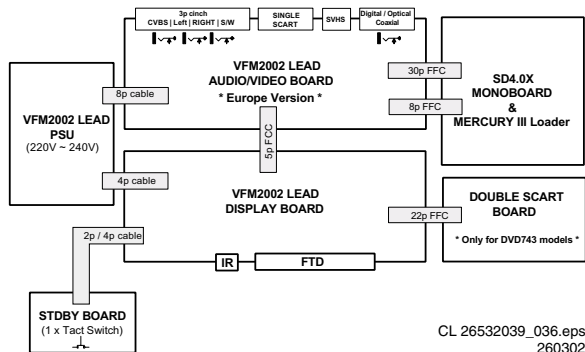

Figure 9-1

The DVD723/743 uses the new SD4.0 loader module. It also has a separate Audio/Video, Display board and a dedicated power supply (based on the VFM2002 type).

This SD4.0 mono board has the same service (ComPair) connector as in previous versions.

Flashing of the application-SW is not possible via the ComPair cable, only with a CD-R disc.

For sets with mask-ROM software, replace it with a programmed Flash (available via your Philips Service organisation).

9.2 Power Supply

9.2.1 Introduction

The supply is a Switching Mode Power Supply (SMPS), which uses the control IC TY720xx to produce pulses to drive the power 'switch' (MOSFET). The TY720xx (item 7130) is a high performance, current mode controller for DC-to-DC converter applications.

The operation frequency varies with the circuit load. When the output power demand decreases, the switching frequency raises, with a maximum frequency of 125 kHz (determined by C2107 at pin 5). At this point, the internal VCO takes over and starts to decrease the switching frequency.

This has some benefits compared to a 'fixed frequency' flyback converter. The efficiency is better, which results in a lower power consumption.

9.2.2 Output Voltages

PSU Connection

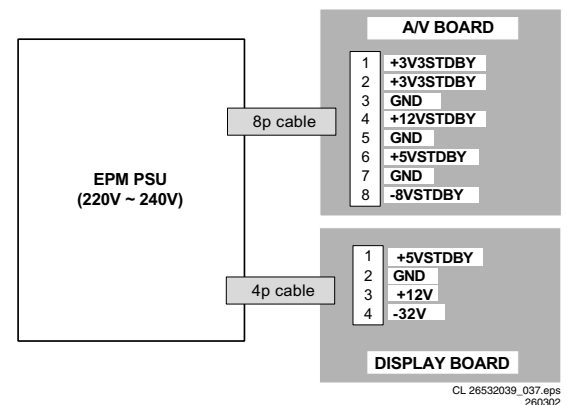

Figure 9-2

The following voltages are connected to the A/V board and Front Display board via connectors 1101 and 1114 (1133) respectively:

- +12VSTBY, 470 mA.
- +5VSTBY, 400 mA.
- +3V3STBY, 1200 mA.
- -8V, 30 mA.
- -32V, 16 mA.

The +12VSTBY, on pin 4 of connector 1101, is further divided into the following voltage:

- +5V_DAC (via voltage regulator 7423), supply to audio DAC, and OpAmp filter.

The +5VSTBY, on pin 6 of connector 1101, is further divided into the following voltages:

- +5V, supply to SD4.0 mono board.
- +5VM, supply for analogue circuitry.

The suffix 'STBY', indicates that the supply is not switched 'off' during Standby Mode. Power switching is done **on the A/V board** with the STBY_CTRL signal from the slave processor.

Power Switching

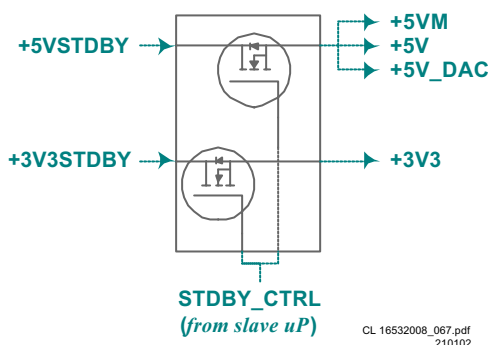

Figure 9-3

The derived voltages +3V3, +5V, and +5V_DAC are switched 'off' during Standby Mode with a MOSFET (see items 7308, 7309, and 7506 on diagram A3).

The -8V is regulated to -5.5V via transistor 7304 and zenerdiode 6308, and is switched 'off', with transistor 7305, during Standby Mode.

The -32V is not switched 'off' during Standby Mode.

9.2.3 Operation

Mains Input Circuit

The bridge rectifier (D6110-D6113), direct after the mains filter 5115, rectifies the mains voltage, after which C2116 smoothens it. The DC voltage across this capacitor is the DC input voltage (HV= approximately 300 V), to pin 9 of transformer T5190 and pin 1 of IC7130.

Start-up Circuitry

The rectified voltage from the bridge rectifier is connected to pin 1 via L5130. It will charge the VCC capacitor (C2131). When this voltage, (at pin 13 of 7130), reaches the start-up threshold of min 15 V, the control circuit starts to operate. After start-up, IC 7130 requires a sinking current, which the start-up circuitry cannot deliver. Therefore, a take-over circuitry (a coupled winding of transformer L5190) is present. The voltage here will take over the supply voltage at pin 13 of the IC. If the take-over circuit does not function, the IC will switch 'off' again at the minimal operating voltage of +8 V. The whole operation cycle will repeat itself with audible hiccup sound if take-over is not present.

Secondary Voltage Sensing

The secondary voltage regulating circuit comprises of opto-coupler 7190 (which isolates the error signal from the control IC on the primary side), and a reference component 7290 (TL431) with the following functions:

- A very stable and accurate reference diode.
- A high gain amplifier.

TL431

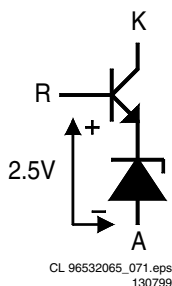

Figure 9-4

When the output voltage increases (due to a reduction in the load), the voltage across R3290+R3291 increases to above the internal reference voltage of 2.5 V. Item 7290 will conduct and the current through the opto-coupler will increase. This results in an increase of the voltage at pin 4 of 7130, which will reduce the 'on' time of FET 7125. In the event of an output voltage decrease (due to an increase in the load), the control circuit will operate in the opposite way.

Primary Current Sensing

The current through FET 7125 will result in a voltage drop across R3120/21/22 (RSENSE). This line goes to pin 11 of 7130, which is the current sense input. The higher the input voltage, the more the primary current is limited. In this way, the maximum output power of the power supply is limited.

Under-voltage Protection

If the supply voltage at pin 13 drops below 7.2 V (typical), e.g. due to a shorted secondary voltage or excessive load, the drive pulse at pin 12 is disabled and the controller will switch 'off'.

Over-voltage Protection

An internal over-voltage protection circuitry continuously monitors the VCC pin. If, after start-up, this voltage exceeds 40 V, the internal latch circuit is triggered, the output buffer is disabled, and the SMPS goes into over-voltage protection. Now a complete restart sequence is required.

Note: If the event of the over-voltage situation remains present, the SMPS will go in sequence of protection, start-up, protection and the cycle repeats. This effect is highly audible.

9.3 Loader/Mono Board

For an extensive circuit description of the SD4.0 Loader/Monoboard, see the **SD4.0 Service Manual 3122 785 12230**.

9.4 Control and Display

Note: There are two different Display panels used, due to different models (DVD723 and DVD743). Both panels will have the same description, except the item number will be different and it will be displayed as XX/YY, where XX refer to the DVD723 Display panel and YY refer to the DVD743 Display panel.

9.4.1 Control

The most important component on this board is the (slave) microprocessor (item 7113/7101). It runs on an 8MHz system clock generated with a ceramic resonator.

After the RESET pulse (active LOW), the STB_CTRL line (pin 21, item 7113/7101) will release the reset of the host uP (on the mono board) via the switched 3V3 supply (see circuit around item 7605 on mono board).

Other slave processor functions are:

- Generation of a scanning grid for the keys.
- Generation of the display grid and segment scanning.
- Generation of a square signal to generate the filament voltage for FTD display.
- Input for RC5/6 remote control protocol. The logic is HIGH > 4.5V and LOW < 0.3V.

Standby LED (only for DVD743 models)

Transistor 7105 drives the Standby LED. When the STBY_LED signal from the slave processor is 'high', the LED is 'off'.

Key Matrix

When a key on the local keyboard is pressed, the signal at the scanning pins of the microprocessor goes from +5V to 0V.

IR Receiver

The IR controller in the slave processor handles both RC5 and RC6 signals. The logic is +5V for 'high' and 0V for 'low'.

P50 Interface (only for DVD743 models)

P50 (or Easylink) is a bi-directional serial interface for communication between video equipment. For European sets, this communication goes via pin 10 of the double SCART.

FTD Display

The slave uP drives the 11-segment FTD. It provides a negative DC switching drive voltage. As the display consists of eleven segments, there are eleven grid signals (G1-G11) controlling each respective grid.

The slave processor has an internal square signal generator (42 kHz), to generate the AC filament voltage. TS7105/7103 and 7106 amplify the square signal before it is applied to the display ($V_{AC} = V_{FIL_1} - V_{FIL_2}$, $V_{RMS} \approx 2.4V$). The necessary power supply of -26V is derived (via zener diode 6101) from the -32V supply directly from the Switching Mode Power Supply (SMPS).

Slave Processor Interface

Figure 9-5

The block diagram above, illustrates the interfaces of the slave uP. The start-up sequence is as follows:

1. The required IC voltage is the +5VSTBY, which is present during Standby Mode.
2. When the RESET circuit (7108/7102) is triggered by the +5VSTBY, the slave uP initialises.
3. This will set the STDBY_CTRL signal to LOW, which will switch on the +3V3 and +5V.
4. Once these voltages are provided, the host uP (on the SD4.0 mono board) will reset.
5. Now, the host uP will initialise, and indicate the slave uP to activate the Standby Mode (STBY_CTRL) signal.
6. The player wakes up from the Standby Mode when any button is pressed on the front panel, or when the 'Power' button is pressed on the Remote Control.

Note: The slave uP will not reset successfully if the 8MHz clock oscillator has not stabilised (check on pin 8 of item 7113/7101).

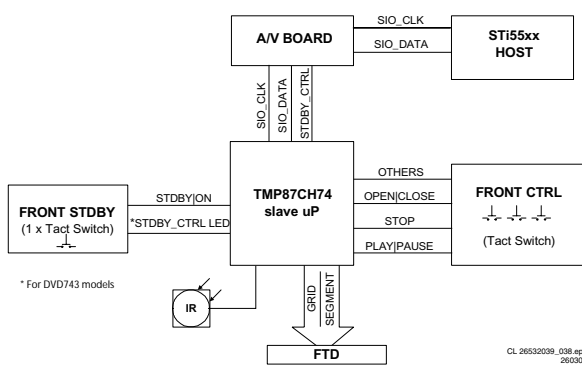
9.5 Audio/Video (A/V) and SCART

The video output from the STi55xx is RGB, YC and CVBS. These signals enter the A/V Board via connector 1100. All these analogue video signals, from the SD4.0 Monoboard, first go through the transistor (item 7168, 7169, 7170, 7160, 7161, 7162, 7163, 7164, 7132) for impedance matching before going directly to the cinch, SVHS and SCART connector. However for double scart models, the RGB signals go directly to the SCART connector 1103.

The '0/6/12' switch signal on pin 8 of the single SCART connector, depends on the logic state of two other signals: SCART0 from the μ P and STBY_CTRL from the slave μ P.

This is done according to the following table:

Status Truth Table

SCART_0	STBY_CTRL	0/6/12	Function
0	0	12V	4:3 aspect ratio DVD
0	1	0V	TV display
1	0	6V	16:9 aspect ratio DVD
1	1	0V	TV display

Figure 9-6

9.5.1 Audio Path**Audio DAC circuitry**

Figure 9-7

The STi55xx supplies I2S data and PCM_CLK master clock to the new audio DAC (item 7200, AK4382AVT).

The decoded analogue output of both left and right channel is balanced. These are filtered (3-pole LPF) and amplified with OpAmp LM833 (item 7211). The gain of this OpAmp is two times.

There is only 2X two stereo output from the A/V Board, a subwoofer, and Digital audio out on coaxial and optical connector.

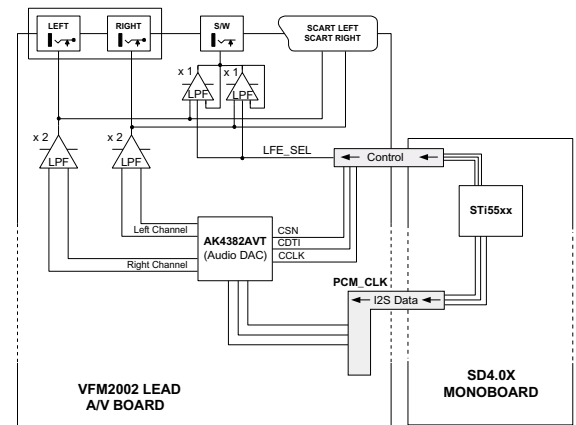
The audio DAC accepts only +5V inputs with +3V3 tolerance. During STDBY mode, there will be no power to the audio DAC. The registers of the audio DAC are in their default values each time the power to the IC is cut-off. The slave uP is required to program the DAC each time after exiting from STDBY mode. This requires three signal lines.

- CSN - Chip Select Pin.
- CCLK - Control Clk Input Pin.
- CDTI - Control Data Input Pin in Serial Mode.

CCLK and CDTI are connected to P1 and P2 of host uP (via conn 1104) respectively for communication between the slave uP and STi55xx.

The host uP (STi55xx) will indicate the slave uP when to program the audio DAC after waking up from STDBY mode.

The audio MUTE signal depends on the logic state of two other signals:

- KILL: This signal comes from the host processor (STi55xx) and is meant to mute the outputs during switch on/off.
- KILL_LR: This is a signal from the audio DAC, when it receives no input for a certain time (8192 LRCK cycles). It can be tested in STOP, PAUSE and during track changes. The logic level for the MUTE signal is -3V < LOW < 0V and 0V < HIGH < +3V.

Mute Truth Table

KILL	KILL_LR	MUTE	Function
0	0	0	Output is not muted.
0	1	1	Output is muted.
1	0	1	Output is muted.
1	1	1	Output is muted.

Figure 9-8

9.6 Abbreviation list

ADC	Analogue to Digital Converter
AM	Amplitude Modulation
AV	External Audio Video
BE	Basic Engine
ComPair	Computer aided rePair
CD-DA	CD Digital Audio
CS	Chip Select
CVBS	Composite Video Blanking and Synchronisation
DAC	Digital to Analogue Converter
DFU	Direction For Use: description for the end user
DNR	Dynamic Noise Reduction
DRAM	Dynamic RAM
DSD	Direct Stream Digital
DSP	Digital Signal Processing
DTS	Digital Theatre Sound
DVD	Digital Versatile Disc
EMI	External Memory Interface (ST155xx)
EXT	External (source), entering the set via SCART or Cinch
FFC	Flat Foil Cable
FLASH	Flash memory
FM	Frequency Modulation
FTD	Fluorescent Tube Display
HP	Headphone
HPF	High Pass Filter
HW	Hardware
I2C	Integrated IC bus
I2S	Integrated IC Sound bus
IC	Integrated Circuit
IF	Intermediate Frequency
IR	Infra Red
IRQ	Interrupt Request
LED	Light Emitting Diode
LPCM	Linear Pulse Code Modulation
LPF	Low Pass Filter
LRCLK	Left/Right clock
LVTTTL	Low Voltage Transistor Transistor Logic (3.3V logic)
MPEG	Motion Pictures Experts Group
NC	Not Connected
NTSC	National Television Standard Committee. Colour system mainly used in North America and Japan. Colour carrier NTSC M/N = 3.579545 MHz, NTSC 4.43 = 4.433619 MHz (this is a VCR norm, it is not transmitted off-air)
NVM	Non Volatile Memory: IC containing TV related data e.g. alignments
OC	Open Circuit
OSD	On Screen Display
P50	Project 50 or Easy Link
PAL	Phase Alternating Line. Colour system mainly used in West Europe (colour carrier = 4.433619 MHz) and South America (colour carrier PAL M = 3.575612 MHz and PAL N = 3.582056 MHz)
PCB	Printed Circuit Board (see PWB)
PCM	Pulse Code Modulation
PCM_CLK	Audio system clock for DAC

PCM_OUTx	Audio serial output data
PSU	Power Supply Unit
PWB	Printed Wiring Board (see PCB)
RAM	Random Access Memory
RC	Remote Control handset
RC5/6	Remote Control system 5/6, signal from/to the remote control receiver
RGB	Red, Green and Blue colour space
ROM	Read Only Memory
SCART	Syndicat des Constructeurs d'Appareils Radiorecepteurs et Televisieurs
SCL	Serial Clock I2C
SCLK	Audio serial bit clock
SDA	Serial Data I2C
SDRAM	Synchronous DRAM
S/PDIF	Sony Philips Digital InterFace
SRAM	Static RAM
STBY	Standby
SVCD	Super Video CD
SVHS	Super Video Home System
SW	Software
THD	Total Harmonic Distortion
TTL	Transistor Transistor Logic (5V logic)
TXT	Teletext
uP	Microprocessor
VCD	Video CD
Y/C	Luminance (Y) and Chrominance (C) signal
YUV	Component video
0/6/12	SCART switch control signal on A/V board. 0 = loop through (AUX to TV), 6 = play 16:9 format, 12 = play 4:3 format

9.7 IC Data

In this paragraph, the internal block diagrams and pinning are given of ICs that are drawn as 'black box' in the electrical diagrams (with the exception of 'memory' and 'logic' ICs).

9.7.1 Diagram Power Supply

TY72011P2 Block Diagram (item 7130)

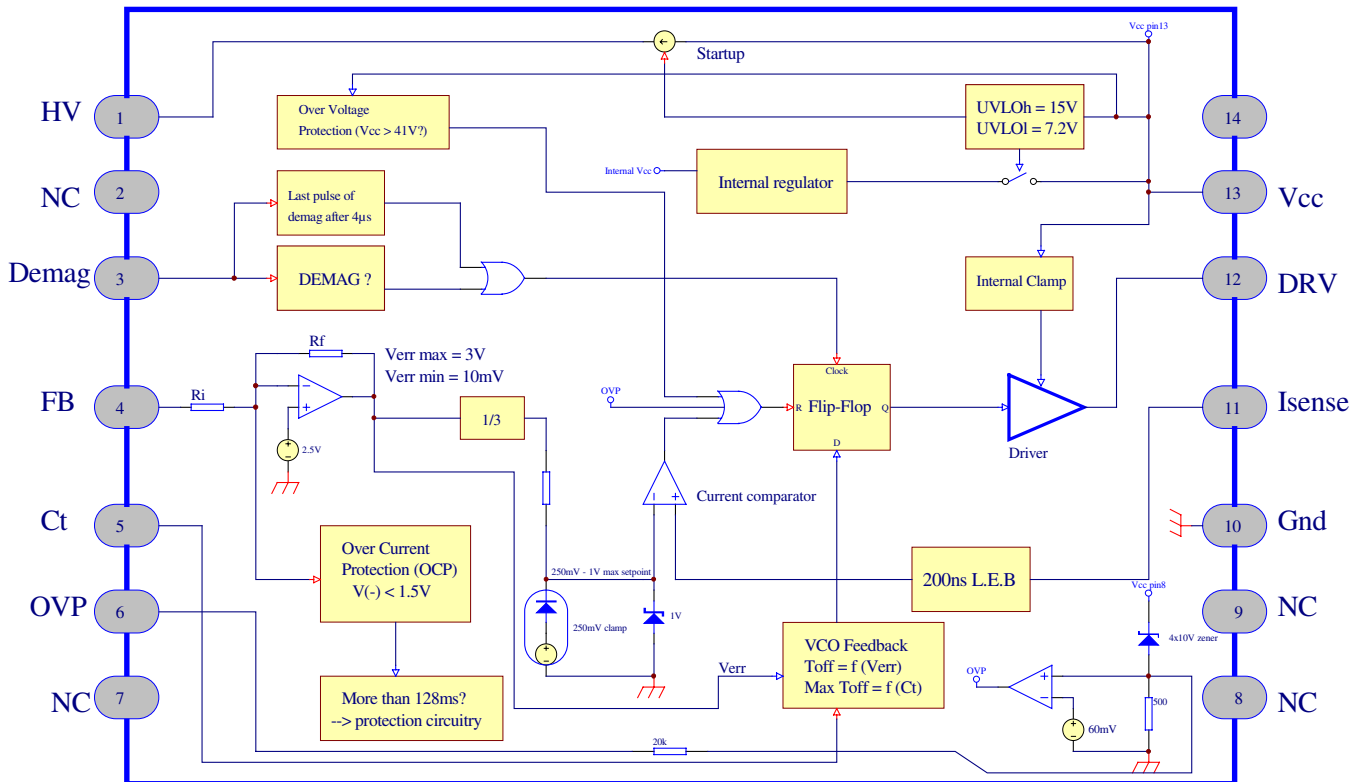
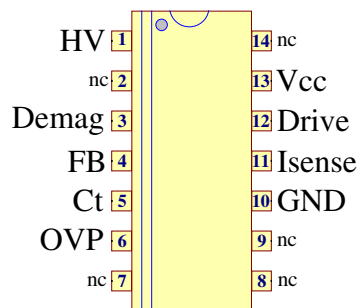

Figure 9-9

TY72011P2 Pinning (item 7130)



PIN CONNECTIONS

Figure 9-10

10. Spare Parts List

Various DVD723/OX1

Various

0001	3139 247 55241	FRONT COMPLETE DVD723
0055	3139 247 55331	ASSY TRAY COVER DVD723
0250	3139 247 55251	PLATE BACK DVD723 PNT PRT
0300	3139 247 55261	COVER TOP DVD723 PNT PRT
0361	4822 321 11196	MAINS CORD 20/21"
0361	3103 140 25882	MAINS CORD 14/20/21"/GB (ONLY FOR /051)
0365	3103 308 92610	CABLE AUDIO 2X2RCA MALE 1.5MTR
0366	4822 321 61579	VIDEO-CABLE
0373	2422 076 00445	CORD SCART 1M1 M 20P BK
0375	3139 246 11711	IFU DVD723/001
0375	3139 246 11703	IFU DVD723/021
0375	3139 246 11693	IFU DVD723/051
0390	3139 228 60251	PROD. ASSY RC19133006/ 01H PKD
1005	3122 427 23111	PSU DVD VFM2002
1101	3139 110 36061	FFC FOIL 08P/100/08P BD 1MMMP
1102	3139 110 36071	FFC FOIL 30P/100/30P BD 1MMMP

AV PWB DVD723/OX1

Various

1003	4822 267 10994	4P, MDIN
1100	2422 025 17433	CON BM V 30P F 1.00 FFC 0.3 B
1101	2422 025 17467	CON BM V 8P M 2.50 MIS B
1102	2422 025 17464	CON BM V 5P M 2.50 MIS B
1104	2422 025 16393	CON BM V 8P F 1.00 FFC 0.3 B
1130	2422 025 12352	CON BM EURO H 21P F BK GRND-L
1140	2422 026 05318	SOC CINCH H 6P F RDWHYEBK B
1230	4822 267 31729	

-I-

2104	4822 126 13883	220pF 5% 50V
2105	4822 126 13883	220pF 5% 50V
2106	3198 016 31020	0603 25V 1nF
2107	4822 122 33761	22pF 5% 50V
2108	4822 122 33761	22pF 5% 50V
2112	4822 124 81044	470µF 20% 6.3V
2130	3198 016 31020	0603 25V 1nF
2131	3198 016 36810	0603 25V 680P COL R
2132	4822 126 14494	22nF 10% 25V 0603
2133	4822 126 13883	220pF 5% 50V
2134	4822 124 40207	100µF 20% 25V
2135	2238 586 59812	0603 50V 100NP80M
2136	3198 017 44740	0603 10V 470nF COL
2137	4822 126 13883	220pF 5% 50V
2138	4822 126 13883	220pF 5% 50V
2139	4822 126 13883	220pF 5% 50V
2140	4822 126 13883	220pF 5% 50V
2141	4822 126 13883	220pF 5% 50V
2150	3198 017 42230	0603 50V 22nF COL
2161	4822 126 13883	220pF 5% 50V
2162	4822 124 80791	470µF 16V 20% 105C DXH=8X11.5
2163	4822 124 80791	470µF 16V 20% 105C DXH=8X11.5
2164	4822 124 80791	470µF 16V 20% 105C DXH=8X11.5
2201	4822 124 40433	47µF 20% 25V
2202	2238 586 59812	0603 50V 100NP80M
2203	2238 586 59812	0603 50V 100NP80M
2204	2238 586 59812	0603 50V 100NP80M
2207	2238 586 59812	0603 50V 100NP80M
2208	4822 126 14494	22nF 10% 25V 0603
2209	4822 124 22339	100UE 16V
2210	4822 126 14494	22nF 10% 25V 0603
2215	3198 016 36810	0603 25V 680P COL R
2219	4822 126 14494	22nF 10% 25V 0603

2221	2238 586 59812	0603 50V 100NP80M
2222	3198 016 36810	0603 25V 680P COL R
2223	4822 126 14494	22nF 10% 25V 0603
2225	3198 016 36810	0603 25V 680P COL R
2229	4822 124 22339	100UE 16V
2230	3198 016 36810	0603 25V 680P COL R
2231	4822 124 40248	10µF 20% 63V
2232	4822 126 13881	470pF 5% 50V
2235	4822 124 40207	100µF 20% 25V
2236	4822 124 40207	100µF 20% 25V
2237	2238 586 59812	0603 50V 100NP80M
2238	4822 126 13881	470pF 5% 50V
2239	4822 126 13881	470pF 5% 50V
2240	4822 124 40248	10µF 20% 63V
2241	4822 126 13881	470pF 5% 50V
2242	5322 126 11579	3.3nF 10% 63V
2243	4822 126 13881	470pF 5% 50V
2244	5322 126 11579	3.3nF 10% 63V
2245	4822 126 13881	470pF 5% 50V
2246	4822 126 13881	470pF 5% 50V
2248	2238 586 59812	0603 50V 100NP80M
2301	4822 124 40207	100µF 20% 25V
2302	4822 124 40196	220µF 20% 16V
2303	2238 586 59812	0603 50V 100NP80M
2304	5322 126 11583	10nF 10% 50V 0603
2306	4822 124 40207	100µF 20% 25V
2307	2238 586 59812	0603 50V 100NP80M
2310	4822 124 40207	100µF 20% 25V
2311	2238 586 59812	0603 50V 100NP80M
2314	2238 586 59812	0603 50V 100NP80M
2315	4822 124 40207	100µF 20% 25V
2316	2238 586 59812	0603 50V 100NP80M
2317	4822 124 40207	100µF 20% 25V
2318	4822 124 40207	100µF 20% 25V
2319	4822 124 40207	100µF 20% 25V
2322	2238 586 59812	0603 50V 100NP80M

3117	4822 051 30759	75Ω 5% 0.062W
3130	4822 051 30471	470Ω 5% 0.062W
3131	4822 051 30272	2k7 5% 0.062W
3132	4822 051 30103	10k 5% 0.062W
3133	4822 051 30471	470Ω 5% 0.062W
3134	4822 051 30272	2k7 5% 0.062W
3135	4822 051 30103	10k 5% 0.062W
3136	4822 051 30221	220Ω 5% 0.062W
3137	4822 051 30561	560Ω 5% 0.062W
3137	4822 117 12968	820Ω 5% 0.62W
3138	4822 117 12925	47k 1% 0.063W 0603
3139	4822 051 30102	1k 5% 0.062W
3140	4822 051 30223	22k 5% 0.062W
3141	4822 051 30759	75Ω 5% 0.062W
3142	4822 051 30759	75Ω 5% 0.062W
3143	4822 051 30561	560Ω 5% 0.062W
3143	4822 117 12968	820Ω 5% 0.62W
3144	4822 051 30759	75Ω 5% 0.062W
3145	4822 051 30561	560Ω 5% 0.062W
3145	4822 117 12968	820Ω 5% 0.62W
3149	4822 051 30759	75Ω 5% 0.062W
3150	4822 051 30471	470Ω 5% 0.062W
3152	4822 051 30103	10k 5% 0.062W
3153	4822 051 30471	470Ω 5% 0.062W
3154	4822 051 30103	10k 5% 0.062W
3155	4822 051 30103	10k 5% 0.062W
3156	4822 051 30221	220Ω 5% 0.062W
3158	4822 051 30272	2k7 5% 0.062W
3159	4822 051 30103	10k 5% 0.062W
3160	4822 051 30561	560Ω 5% 0.062W
3171	4822 051 30101	100Ω 5% 0.062W
3172	4822 051 30101	100Ω 5% 0.062W
3174	4822 051 30101	100Ω 5% 0.062W
3175	4822 117 12968	820Ω 5% 0.62W
3176	4822 051 30689	68Ω 5% 0.063W 0603 RC21 RST SM
3177	4822 051 30101	100Ω 5% 0.062W
3178	4822 117 12968	820Ω 5% 0.62W
3179	4822 051 30689	68Ω 5% 0.063W 0603 RC21 RST SM
3180	4822 051 30101	100Ω 5% 0.062W
3181	4822 051 30101	100Ω 5% 0.062W
3182	4822 051 30689	68Ω 5% 0.063W 0603 RC21 RST SM
3183	4822 117 12968	820Ω 5% 0.62W
3201	4822 051 30222	2k2 5% 0.062W
3202	4822 051 30272	2k7 5% 0.062W
3203	4822 051 30472	4k7 5% 0.062W
3204	4822 051 30272	2k7 5% 0.062W
3205	4822 051 30103	10k 5% 0.062W

3206	4822 051 30333	33k 5% 0.062W
3207	4822 051 30272	2k7 5% 0.062W
3208	4822 051 30471	470Ω 5% 0.062W
3209	4822 051 30101	100Ω 5% 0.062W
3213	4822 051 30471	470Ω 5% 0.062W
3214	4822 051 30272	2k7 5% 0.062W
3215	4822 051 30103	10k 5% 0.062W
3217	4822 051 30222	2k2 5% 0.062W
3219	4822 051 30333	33k 5% 0.062W
3223	4822 051 30471	470Ω 5% 0.062W
3224	4822 051 30272	2k7 5% 0.062W
3225	4822 051 30472	4k7 5% 0.062W
3227	4822 051 30272	2k7 5% 0.062W
3229	4822 051 30103	10k 5% 0.062W
3230	4822 051 30103	10k 5% 0.062W
3231	4822 051 30339	33k 5% 0.062W
3232	4822 051 30331	330Ω 5% 0.062W
3233	4822 051 30681	680Ω 5% 0.062W
3234	4822 051 30472	4k7 5% 0.062W
3235	5322 117 13026	4k7 1% 0.063W 0603 RC22H
3236	2322 704 65102	RST SM 0603 RC22H 5k1 PM1
3237	2322 704 62001	RST SM 0603 RC22H 200Ω PM1 R
3239	2322 704 62001	RST SM 0603 RC22H 200Ω PM1 R
3240	5322 117 13026	4k7 1% 0.063W 0603 RC22H
3241	2322 704 65102	RST SM 0603 RC22H 5k1 PM1
3242	2322 704 65102	RST SM 0603 RC22H 5k1 PM1
3243	5322 117 13026	4k7 1% 0.063W 0603 RC22H
3245	2322 704 62001	RST SM 0603 RC22H 200Ω PM1 R
3246	2322 704 62001	RST SM 0603 RC22H 200Ω PM1 R
3247	5322 117 13026	4k7 1% 0.063W 0603 RC22H
3248	2322 704 65102	RST SM 0603 RC22H 5k1 PM1
3251	4822 051 30681	680Ω 5% 0.062W
3252	4822 051 30471	470Ω 5% 0.062W
3253	4822 051 30101	100Ω 5% 0.062W
3301	4822 051 30103	10k 5% 0.062W
3302	4822 117 12925	47k 1% 0.063W 0603
3303	4822 051 30563	56k 5% 0.062W
3304	4822 051 30103	10k 5% 0.062W
3305	4822 051 30472	4k7 5% 0.062W
3306	4822 051 30331	330Ω 5% 0.062W
3307	4822 051 30272	2k7 5% 0.062W
3308	4822 051 30472	4k7 5% 0.062W
3309	4822 051 30103	10k 5% 0.062W
3310	4822 051 30472	4k7 5% 0.062W
3311	4822 051 30103	10k 5% 0.062W
3312	4822 051 30472	4k7 5% 0.062W
3313	4822 051 30684	680k 5% 0.062W
3316	4822 051 30102	1k 5% 0.062W
3319	4822 051 30222	2k2 5% 0.062W
3320	4822 051 30102	1k 5% 0.062W
3423	4822 051 30102	1k 5% 0.062W
3424	4822 051 30102	1k 5% 0.062W
3425	4822 051 30103	10k 5% 0.062W
6302	4822 130 11397	BAS316
6308	4822 130 11378	BZX284-C6V2
7130	4822 130 42804	BC817-25
7131	4822 130 42804	BC817-25
7132	5322 130 60159	BC846B
7133	5322 130 60159	BC846B
7134	4822 130 60373	BC856B
7150	5322 130 60159	BC846B
7151	5322 130 60159	BC846B
7160	5322 130 60159	BC846B
7161	5322 130 60159	BC846B
7164	5322 130 60159	BC846B
7166	4822 130 42804	BC817-25
7168	5322 130 60159	BC846B
7169	5322 130 60159	BC846B
7170	5322 130 60159	BC846B
7200	9322 177 09685	IC SM AK4382AVT (AKM0) R
7211	4822 209 30095	LM833D
7212	4822 209 30095	LM833D
7214	4822 130 42804	BC817-25

7215	4822 130 42804	BC817-25	3167	4822 051 30472	4k7 5% 0.062W
7216	4822 130 42804	BC817-25	3168	4822 051 30472	4k7 5% 0.062W
7217	4822 130 42804	BC817-25	3169	4822 051 30472	4k7 5% 0.062W
7218	9322 155 28667	OPT FIB CON GP1FA550TZ (SRPJL)	3170	4822 051 30472	4k7 5% 0.062W
7300	5322 130 60159	BC846B	3171	4822 051 30472	4k7 5% 0.062W
7301	4822 130 60373	BC856B	3172	4822 051 30103	10k 5% 0.062W
7302	4822 051 30472	4K70 5% 0,062W	3173	4822 051 30472	4k7 5% 0.062W
7303	4822 130 60373	BC856B	3174	4822 051 30472	4k7 5% 0.062W
7304	3198 010 44350	TRA SIG SM BC807-25W (COL) R	3175	4822 051 30103	10k 5% 0.062W
7305	3198 010 44350	TRA SIG SM BC807-25W (COL) R	3176	4822 051 30103	10k 5% 0.062W
7306	5322 130 60159	BC846B	3178	4822 051 30109	10Ω 5% 0.062W
7308	9322 163 53685	FET POW SM IRLML2502 (INR0) R	3180	4822 051 30109	10Ω 5% 0.062W
7309	9322 163 53685	FET POW SM IRLML2502 (INR0) R	3181	4822 051 30109	10Ω 5% 0.062W
7423	4822 209 90927	L78L05ACD	3182	4822 051 30472	4k7 5% 0.062W
7503	5322 130 60159	BC846B	3183	4822 051 30102	1k 5% 0.062W
7505	5322 130 60159	BC846B	3184	4822 051 30331	330Ω 5% 0.062W
7506	9322 163 53685	FET POW SM IRLML2502 (INR0) R	3185	4822 051 30331	330Ω 5% 0.062W
			3186	4822 051 30103	10k 5% 0.062W
			3187	4822 051 30471	470Ω 5% 0.062W
			3188	4822 051 30472	4k7 5% 0.062W
			3189	4822 051 30103	10k 5% 0.062W
			3190	4822 051 30471	470Ω 5% 0.062W
			3191	4822 051 30103	10k 5% 0.062W
Front PWB DVD723/0X1			→		
Various			→		
1100	4822 276 13775	SWITCH	6100	4822 130 11397	BAS316
1101	4822 276 13775	SWITCH	6101	9965 000 04709	UDZ6.2BTE-17
1105	4822 276 13775	SWITCH	6102	9965 000 04709	UDZ6.2BTE-17
1106	4822 276 13775	SWITCH	6104	4822 130 11397	BAS316
1107	4822 276 13775	SWITCH	6105	4822 130 11397	BAS316
1108	4822 276 13775	SWITCH			
1112	2422 527 01005	BUZZER PIEZO PKM13EPY-4002 Y			
1113	3139 240 50211	FTD 11-MT-130GNK DVD LEAD2002			
1114	2422 025 17475	CON BM H 4P M 2.50 MIS B			
1115	2422 025 17476	CON BM H 5P M 2.50 MIS B			
1116	2422 025 17473	CON BM H 2P M 2.50 MIS B			
1117	2422 540 98518	RES CER 8MHz CSTS*MHz 03 A			
1200	2422 025 17473	CON BM H 2P M 2.50 MIS B			
1201	4822 276 13775	SWITCH			
-II-			→		
2105	4822 124 23052	100μF 20% 16V			
2106	4822 124 23052	100μF 20% 16V			
2116	4822 126 14549	33nF 16V O6O3			
2123	4822 124 23052	100μF 20% 16V			
2124	3198 029 52290	EL 7MM 50V 22μF PM20 COL A			
2126	4822 124 40769	4.7μF 20% 100V			
2129	3198 029 52290	EL 7MM 50V 22μF PM20 COL A			
2130	4822 126 13883	220pF 5% 50V			
2131	4822 126 13883	220pF 5% 50V			
2132	4822 126 14549	33nF 16V O6O3			
2133	3198 029 52290	EL 7MM 50V 22μF PM20 COL A			
2134	3198 017 34730	0603 16V 47nF COL			
2135	4822 122 33761	22pF 5% 50V			
2136	4822 122 33761	22pF 5% 50V			
2137	4822 126 14549	33nF 16V O6O3			
2138	4822 122 33761	22pF 5% 50V			
2139	4822 126 14549	33nF 16V O6O3			
2140	5322 126 11578	1nF 10% 50V 0603			
2141	5322 126 11578	1nF 10% 50V 0603			
→			→		
3100	4822 051 30103	10k 5% 0.062W			
3101	4822 117 13608	4.7Ω 5% 0603 0.0016W			
3102	4822 051 30332	3k3 5% 0.062W			
3103	4822 117 13608	4.7Ω 5% 0603 0.0016W			
3104	4822 051 30332	3k3 5% 0.062W			
3105	4822 117 13613	2Ω 5% 0603			
3106	4822 051 30103	10k 5% 0.062W			
3107	4822 117 13608	4.7Ω 5% 0603 0.0016W			
3108	4822 117 13613	2Ω 5% 0603			
3109	4822 051 30221	220Ω 5% 0.062W			
3159	4822 051 30472	4k7 5% 0.062W			
3160	4822 051 30223	22k 5% 0.062W			
3161	4822 051 30273	27k 5% 0.062W			
3162	4822 117 12925	47k 1% 0.063W 0603			
3163	4822 117 13632	100k 1% 0603 0.62W			
3164	4822 051 30221	220Ω 5% 0.062W			
3165	4822 051 30109	10Ω 5% 0.062W			
3166	4822 051 30472	4k7 5% 0.062W			

Various DVD743/OX1**Various**

0001	3139 247 55501	ASSY FRONT DVD743
0095	3139 247 55411	ASSY TRAY COVER DVD743
0098	3139 243 10101	FILTER FTD DVD870L
0120	3139 247 55421	BUTTON NAVI DVD743 PPT
0148	3139 247 55492	ASSY FRAME DVD743
0250	3139 247 55401	PLATE BACK DVD743 PNT PRT
0300	3139 247 55511	COVER TOP DVD743 PPT
0350	3139 228 60251	PROD. ASSY RC19133006/ 01H PKD
0360▲	4822 321 11196	MAINS CORD 20/21"
0360	3103 140 25882	MAINS CORD 14/20/21"/GB (ONLY FUR/051)
0365	3103 308 92610	CABLE AUDIO 2X2RCA MALE 1.5MTR
0366	4822 321 61579	VIDEO-CABLE
0372	3111 170 21992	SCART CABLE (L=1.10M) BMS
0375	3139 246 11741	IFU DVD743/00X
0375	3139 246 11732	IFU DVD743/02X
0375	3139 246 11722	IFU DVD743/05X
1005	3122 427 23351	PSU DVD VFM2002 SURGE PROT. EU
1101	3139 110 36061	FFC FOIL 08P/100/08P BD 1MMMP
1102	3139 110 36071	FFC FOIL 30P/100/30P BD 1MMMP
1107	3104 157 11190	CWAS FLEX DVD 22 130 32S

Module SD4**Various**

0001	9305 023 61301	VAL6013/01 (PHOS) B
1301	3139 241 00131	FFC FOIL 23P/158/23P 1MMMP FOLD

AV PWB DVD743/OX1**Various**

1003	4822 267 10994	4P, MDIN
1100	2422 025 17433	CON BM V 30P F 1.00 FFC 0.3 B
1101	2422 025 17467	CON BM V 8P M 2.50 MIS B
1102	2422 025 17464	CON BM V 5P M 2.50 MIS B
1103	4822 265 11154	52030-2210 (22P)
1104	2422 025 16393	CON BM V 8P F 1.00 FFC 0.3 B
1140	2422 026 05318	SOC CINCH H 6P F RDWHYEBK B
1230	4822 267 31729	

-II-

2104	4822 126 13883	220pF 5% 50V
2105	4822 126 13883	220pF 5% 50V
2107	4822 122 33761	22pF 5% 50V
2108	4822 122 33761	22pF 5% 50V
2112	4822 124 81044	470μF 20% 6.3V
2131	3198 016 36810	0603 25V 680P COL R
2133	4822 126 13883	220pF 5% 50V
2136	3198 017 44740	0603 10V 470nF COL
2137	4822 126 13883	220pF 5% 50V
2138	4822 126 13883	220pF 5% 50V
2139	4822 126 13883	220pF 5% 50V
2150	3198 017 42230	0603 50V 22nF COL
2161	4822 126 13883	220pF 5% 50V
2201	4822 124 40433	47μF 20% 25V
2202	2238 586 59812	0603 50V 100NP80M
2203	2238 586 59812	0603 50V 100NP80M
2204	2238 586 59812	0603 50V 100NP80M
2207	2238 586 59812	0603 50V 100NP80M
2208	4822 126 14494	22nF 10% 25V 0603
2209	4822 124 22339	100UE 16V
2210	4822 126 14494	22nF 10% 25V 0603
2215	3198 016 36810	0603 25V 680P COL R
2219	4822 126 14494	22nF 10% 25V 0603
2221	2238 586 59812	0603 50V 100NP80M
2222	3198 016 36810	0603 25V 680P COL R
2223	4822 126 14494	22nF 10% 25V 0603
2225	3198 016 36810	0603 25V 680P COL R

2229	4822 124 22339	100UE 16V
2230	3198 016 36810	0603 25V 680P COL R
2231	4822 124 40248	10μF 20% 63V
2232	4822 126 13881	470pF 5% 50V
2235	4822 124 40207	100μF 20% 25V
2236	4822 124 40207	100μF 20% 25V
2237	2238 586 59812	0603 50V 100NP80M
2238	4822 126 13881	470pF 5% 50V
2239	4822 126 13881	470pF 5% 50V
2240	4822 124 40248	10μF 20% 63V
2241	4822 126 13881	470pF 5% 50V
2242	5322 126 11579	3.3nF 10% 63V
2243	4822 126 13881	470pF 5% 50V
2244	5322 126 11579	3.3nF 10% 63V
2245	4822 126 13881	470pF 5% 50V
2246	4822 126 13881	470pF 5% 50V
2248	2238 586 59812	0603 50V 100NP80M
2301	4822 124 40207	100μF 20% 25V
2302	4822 124 40196	220μF 20% 16V
2303	2238 586 59812	0603 50V 100NP80M
2304	5322 126 11583	10nF 10% 50V 0603
2306	4822 124 40207	100μF 20% 25V
2307	2238 586 59812	0603 50V 100NP80M
2310	4822 124 40207	100μF 20% 25V
2311	2238 586 59812	0603 50V 100NP80M
2314	2238 586 59812	0603 50V 100NP80M
2315	4822 124 40207	100μF 20% 25V
2316	2238 586 59812	0603 50V 100NP80M
2317	4822 124 40207	100μF 20% 25V
2318	4822 124 40207	100μF 20% 25V
2319	4822 124 40207	100μF 20% 25V
2322	2238 586 59812	0603 50V 100NP80M



3117	4822 051 30759	75Ω 5% 0.062W
3118	4822 051 30561	560Ω 5% 0.062W
3119	4822 051 30759	75Ω 5% 0.062W
3137	4822 051 30561	560Ω 5% 0.062W
3142	4822 051 30759	75Ω 5% 0.062W
3143	4822 117 12968	820Ω 5% 0.62W
3144	4822 051 30759	75Ω 5% 0.062W
3145	4822 117 12968	820Ω 5% 0.62W
3147	4822 051 30561	560Ω 5% 0.062W
3149	4822 051 30759	75Ω 5% 0.062W
3150	4822 051 30471	470Ω 5% 0.062W
3152	4822 051 30103	10k 5% 0.062W
3153	4822 051 30471	470Ω 5% 0.062W
3154	4822 051 30103	10k 5% 0.062W
3155	4822 051 30103	10k 5% 0.062W
3156	4822 051 30221	220Ω 5% 0.062W
3157	4822 051 30759	75Ω 5% 0.062W
3158	4822 051 30272	2k7 5% 0.062W
3159	4822 051 30103	10k 5% 0.062W
3160	4822 051 30561	560Ω 5% 0.062W
3161	4822 051 30759	75Ω 5% 0.062W
3162	4822 051 30759	75Ω 5% 0.062W
3163	4822 051 30759	75Ω 5% 0.062W
3164	4822 051 30759	75Ω 5% 0.062W
3165	4822 051 30759	75Ω 5% 0.062W
3166	4822 051 30759	75Ω 5% 0.062W
3167	4822 051 30101	100Ω 5% 0.062W
3168	4822 051 30101	100Ω 5% 0.062W
3169	4822 051 30101	100Ω 5% 0.062W
3170	4822 051 30101	100Ω 5% 0.062W
3171	4822 051 30101	100Ω 5% 0.062W
3172	4822 051 30101	100Ω 5% 0.062W
3201	4822 051 30222	2k2 5% 0.062W
3202	4822 051 30272	2k7 5% 0.062W
3203	4822 051 30472	4k7 5% 0.062W
3204	4822 051 30272	2k7 5% 0.062W
3205	4822 051 30103	10k 5% 0.062W
3206	4822 051 30333	33k 5% 0.062W
3207	4822 051 30272	2k7 5% 0.062W
3208	4822 051 30471	470Ω 5% 0.062W
3209	4822 051 30101	100Ω 5% 0.062W
3213	4822 051 30471	470Ω 5% 0.062W
3214	4822 051 30272	2k7 5% 0.062W
3215	4822 051 30103	10k 5% 0.062W
3217	4822 051 30222	2k2 5% 0.062W
3219	4822 051 30333	33k 5% 0.062W
3223	4822 051 30471	470Ω 5% 0.062W
3224	4822 051 30272	2k7 5% 0.062W
3225	4822 051 30472	4k7 5% 0.062W
3227	4822 051 30272	2k7 5% 0.062W
3229	4822 051 30103	10k 5% 0.062W
3230	4822 051 30103	10k 5% 0.062W
3231	4822 051 30339	33Ω 5% 0.062W
3232	4822 051 30331	330Ω 5% 0.062W
3233	4822 051 30681	680Ω 5% 0.062W
3234	4822 051 30472	4k7 5% 0.062W
3235	5322 117 13026	4k7 1% 0.063W 0603 RC22H

3236	2322 704 65102	RST SM 0603 RC22H 5k1 PM1
3237	2322 704 62001	RST SM 0603 RC22H 200Ω PM1 R
3239	2322 704 62001	RST SM 0603 RC22H 200Ω PM1 R
3240	5322 117 13026	4k7 1% 0.063W 0603 RC22H
3241	2322 704 65102	RST SM 0603 RC22H 5k1 PM1
3242	2322 704 65102	RST SM 0603 RC22H 5k1 PM1
3243	5322 117 13026	4k7 1% 0.063W 0603 RC22H
3245	2322 704 62001	RST SM 0603 RC22H 200Ω PM1 R
3246	2322 704 62001	RST SM 0603 RC22H 200Ω PM1 R
3247	5322 117 13026	4k7 1% 0.063W 0603 RC22H
3248	2322 704 65102	RST SM 0603 RC22H 5k1 PM1
3251	4822 051 30681	680Ω 5% 0.062W
3252	4822 051 30471	470Ω 5% 0.062W
3253	4822 051 30101	100Ω 5% 0.062W
3301	4822 051 30103	10k 5% 0.062W
3302	4822 117 12925	47k 1% 0.063W 0603
3303	4822 051 30563	56k 5% 0.062W
3304	4822 051 30103	10k 5% 0.062W
3305	4822 051 30472	4k7 5% 0.062W
3306	4822 051 30331	330Ω 5% 0.062W
3307	4822 051 30272	2k7 5% 0.062W
3308	4822 051 30472	4k7 5% 0.062W
3309	4822 051 30103	10k 5% 0.062W
3310	4822 051 30472	4k7 5% 0.062W
3311	4822 051 30103	10k 5% 0.062W
3312	4822 051 30472	4k7 5% 0.062W
3313	4822 051 30684	680k 5% 0.062W
3316	4822 051 30102	1k 5% 0.062W
3319	4822 051 30222	2k2 5% 0.062W
3320	4822 051 30102	1k 5% 0.062W
3423	4822 051 30102	1k 5% 0.062W
3424	4822 051 30102	1k 5% 0.062W
3425	4822 051 30103	10k 5% 0.062W



6302	4822 130 11397	BAS316
6308	4822 130 11378	BZX284-C6V2



7132	5322 130 60159	BC846B
7150	5322 130 60159	BC846B
7151	5322 130 60159	BC846B
7160	5322 130 60159	BC846B
7161	5322 130 60159	BC846B
7162	5322 130 60159	BC846B
7163	5322 130 60159	BC846B
7164	5322 130 60159	BC846B
7166	4822 130 42804	BC817-25
7200	9322 177 09685	IC SM AK4382AVT (AKMO) R
7211	4822 209 30095	LM833D
7212	4822 209 30095	LM833D
7214	4822 130 42804	BC817-25
7215	4822 130 42804	BC817-25
7216	4822 130 42804	BC817-25
7217	4822 130 42804	BC817-25
7218	9322 155 28667	OPT FIB CON GP1FA550TZ (SRP)JL
7300	5322 130 60159	BC846B
7301	4822 130 60373	BC856B
7303	4822 130 60373	BC856B
7304	3198 010 44350	TRA SIG SM BC807-25W (COL) R
7305	3198 010 44350	TRA SIG SM BC807-25W (COL) R
7306	5322 130 60159	BC846B
7308	9322 163 53685	FET POW SM IRLML2502 (INRO) R
7309	9322 163 53685	FET POW SM IRLML2502 (INRO) R
7423	4822 209 90927	L78L05ACD
7503	5322 130 60159	BC846B
7505	5322 130 60159	BC846B
7506	9322 163 53685	FET POW SM IRLML2502 (INRO) R

Front PWB DVD743/OX1

Various

1100	3139	240	50211	FTD 11-MT-130GNK DVD LEAD2002
1109	4822	276	13775	SWITCH
1113	4822	276	13775	SWITCH
1118	4822	276	13775	SWITCH
1119	4822	276	13775	SWITCH
1120	4822	276	13775	SWITCH
1121	4822	276	13775	SWITCH
1122	4822	276	13775	SWITCH
1123	4822	276	13775	SWITCH
1125	4822	276	13775	SWITCH
1127	2422	025	17476	CON BM H 5P M 2.50 MIS B
1128	2422	540	98518	RES CER 8MHz CSTS*MHz 03 A
1130	2422	527	01005	BUZZER PIEZO PKM13EPY-4002 Y
1131	2422	025	17475	CON BM H 4P M 2.50 MIS B
1132	2422	128	03034	SWI TACT NAV 1P 4POS SKQUAA R
1133	2422	025	17463	CON BM V 4P M 2.50 MIS B
1200	2422	025	17475	CON BM H 4P M 2.50 MIS B
1201	4822	276	13775	SWITCH

-II-

2100	4822	126	13883	220pF 5% 50V
2101	4822	126	13883	220pF 5% 50V
2102	4822	126	14549	33nF 16V O6O3
2104	3198	024	44730	47nF 50V 0603
2106	4822	124	41643	100µF 20% 16V DIM:6.3X11MM
2107	4822	122	33761	22pF 5% 50V
2110	4822	122	33761	22pF 5% 50V
2111	3198	028	52290	22µF 20% 50V
2112	4822	126	14549	33nF 16V O6O3
2113	4822	124	12032	4.7µF 20% 50V
2114	5322	126	11578	1nF 10% 50V 0603
2115	4822	126	14549	33nF 16V O6O3
2116	5322	126	11578	1nF 10% 50V 0603
2117	4822	126	14549	33nF 16V O6O3
2118	4822	124	81286	47µF 20% 16V
2119	3198	028	42290	EL 5MM 35V 22µF PM20 COL A
2120	4822	122	33761	22pF 5% 50V
2121	4822	122	33761	22pF 5% 50V
2122	4822	126	14549	33nF 16V O6O3
2123	4822	124	11947	10µF 20% 16V
2124	4822	122	33761	22pF 5% 50V
2125	3198	028	42290	EL 5MM 35V 22µF PM20 COL A

□

3100	4822	117	13608	4.7Ω 5% 0603 0.0016W
3102	4822	117	13613	2Ω 5% 0603
3103	4822	117	13608	4.7Ω 5% 0603 0.0016W
3104	4822	117	13613	2Ω 5% 0603
3105	4822	051	30223	22k 5% 0.062W
3106	4822	051	30273	27k 5% 0.062W
3107	4822	117	12925	47k 1% 0.063W 0603
3108	4822	117	13632	100k 1% 0603 0.62W
3109	4822	051	30221	220Ω 5% 0.062W
3110	4822	051	30472	4k7 5% 0.062W
3111	4822	051	30103	10k 5% 0.062W
3112	4822	051	30472	4k7 5% 0.062W
3113	4822	051	30472	4k7 5% 0.062W
3114	4822	051	30472	4k7 5% 0.062W
3115	4822	051	30472	4k7 5% 0.062W
3116	4822	051	30472	4k7 5% 0.062W
3117	4822	051	30472	4k7 5% 0.062W
3118	4822	051	30103	10k 5% 0.062W
3119	4822	051	30103	10k 5% 0.062W
3120	4822	117	11152	4Ω7 5%
3121	4822	051	30109	10Ω 5% 0.062W
3122	4822	051	30103	10k 5% 0.062W
3123	4822	051	30101	100Ω 5% 0.062W
3124	4822	051	30101	100Ω 5% 0.062W
3125	4822	051	30109	10Ω 5% 0.062W
3126	4822	051	30472	4k7 5% 0.062W
3127	4822	051	30109	10Ω 5% 0.062W
3128	4822	051	30109	10Ω 5% 0.062W
3129	4822	051	30102	1k 5% 0.062W
3130	4822	051	30103	10k 5% 0.062W
3131	4822	051	30331	330Ω 5% 0.062W
3132	4822	051	30331	330Ω 5% 0.062W
3133	4822	051	30103	10k 5% 0.062W
3134	4822	051	30221	220Ω 5% 0.062W

3135	4822	051	30331	330Ω 5% 0.062W
3136	4822	051	30103	10k 5% 0.062W
3137	4822	117	11152	4Ω7 5%
3138	4822	051	30471	470Ω 5% 0.062W
3139	4822	051	30472	4k7 5% 0.062W
3140	4822	051	30109	10Ω 5% 0.062W
3141	4822	051	30103	10k 5% 0.062W
3142	4822	051	30471	470Ω 5% 0.062W
3143	4822	117	11152	4Ω7 5%
3144	4822	117	11152	4Ω7 5%
3145	4822	051	30472	4k7 5% 0.062W
3146	4822	051	30332	3k3 5% 0.062W
3147	4822	051	30332	3k3 5% 0.062W
3148	4822	051	30103	10k 5% 0.062W
3200	4822	051	30101	100Ω 5% 0.062W

➔

6100	4822	130	11397	BAS316
6101	9965	000	04709	UDZ6.2BTE-17
6102	4822	130	11397	BAS316
6103	4822	130	11397	BAS316
6104	9965	000	04709	UDZ6.2BTE-17
6200	4822	130	82978	LTL-16KPE-P

□

7100	5322	130	60159	BC846B
7101	3139	240	50271	IC SM TMP87CH74F-3PG5 DVDV2.22
7102	5322	130	60159	BC846B
7103	4822	130	40981	BC337-25
7104	9322	155	82667	IR RECEIVER TSOP2236
7105	4822	130	60373	BC856B
7106	4822	130	41246	BC327-25
7107	5322	130	60159	BC846B

SCART PWB DVD743/OX1

Various

1000	2422	025	12352	CON BM EURO H 21P F BK GRND-L
1001	2422	025	12352	CON BM EURO H 21P F BK GRND-L
1300	2422	025	16526	CON BM V 22P F 1.00 FFC 0.3 R

-II-

2100	4822	124	11947	10µF 20% 16V
2101	4822	124	40207	100µF 20% 25V
2102	4822	126	14305	100nF 10% 16V 0603
2103	4822	126	14305	100nF 10% 16V 0603
2104	4822	126	14305	100nF 10% 16V 0603
2105	4822	122	33777	47pF 5% 63V
2106	4822	122	33777	47pF 5% 63V
2107	4822	126	14305	100nF 10% 16V 0603
2108	4822	126	14305	100nF 10% 16V 0603
2109	4822	126	14305	100nF 10% 16V 0603
2110	4822	124	41584	100µF 20% 10V
2111	4822	126	14494	22nF 10% 25V 0603
2112	4822	126	14305	100nF 10% 16V 0603
2113	4822	126	14305	100nF 10% 16V 0603
2114	3198	017	44740	0603 10V 470nF COL
2115	3198	017	44740	0603 10V 470nF COL
2116	3198	017	44740	0603 10V 470nF COL
2117	4822	124	11947	10µF 20% 16V
2118	4822	124	11947	10µF 20% 16V
2119	4822	124	21732	10µF 20% 25V
2120	3198	017	44740	0603 10V 470nF COL
2121	4822	124	40207	100µF 20% 25V
2122	4822	126	14305	100nF 10% 16V 0603
2200	4822	124	12032	4.7µF 20% 50V
2201	4822	126	13883	220pF 5% 50V
2202	4822	124	12032	4.7µF 20% 50V
2203	4822	124	12032	4.7µF 20% 50V
2204	4822	124	12032	4.7µF 20% 50V
2205	4822	122	31765	100pF 2% 63V 1206
2206	4822	126	13883	220pF 5% 50V
2207	4822	126	13883	220pF 5% 50V
2208	4822	126	13883	220pF 5% 50V
2209	4822	126	13883	220pF 5% 50V
2210	4822	126	13883	220pF 5% 50V
2211	4822	124	21732	10µF 20% 25V
2212	4822	124	12032	4.7µF 20% 50V
2213	4822	124	12032	4.7µF 20% 50V
2214	4822	124	12032	4.7µF 20% 50V
2215	4822	124	12032	4.7µF 20% 50V
2216	4822	126	13883	220pF 5% 50V

□

3100	4822	117	11152	4Ω7 5%
3102	4822	051	30103	10k 5% 0.062W
3104	4822	051	30472	4k7 5% 0.062W
3105	4822	051	30103	10k 5% 0.062W
3106	4822	051	30103	10k 5% 0.062W
3107	4822	051	30101	100Ω 5% 0.062W
3108	4822	051	30101	100Ω 5% 0.062W
3109	4822	051	30472	4k7 5% 0.062W
3110	4822	051	30103	10k 5% 0.062W
3111	4822	051	30102	1k 5% 0.062W
3112	4822	051	30472	4k7 5% 0.062W
3113	4822	051	30103	10k 5% 0.062W
3114	4822	051	30471	470Ω 5% 0.062W
3115	4822	051	30471	470Ω 5% 0.062W
3116	4822	051	30103	10k 5% 0.062W
3117	4822	051	30472	4k7 5% 0.062W
3200	4822	051	30221	220Ω 5% 0.062W
3201	4822	117	12925	47k 1% 0.063W 0603
3202	4822	051	30471	470Ω 5% 0.062W
3203	4822	051	30273	27k 5% 0.062W
3204	4822	117	12925	47k 1% 0.063W 0603
3205	4822	051	30221	220Ω 5% 0.062W
3206	4822	117	12925	47k 1% 0.063W 0603
3207	4822	051	30273	27k 5% 0.062W
3208	4822	117	12925	47k 1% 0.063W 0603
3209	4822	051	30471	470Ω 5% 0.062W
3210	4822	051	30471	470Ω 5% 0.062W
3211	4822	051	30101	100Ω 5% 0.062W
3212	4822	051	30689	68Ω 5% 0.063W 0603 RC21 RST SM
3213	4822	051	30471	470Ω 5% 0.062W
3214	4822	051	30471	470Ω 5% 0.062W
3215	4822	051	30101	100Ω 5% 0.062W
3216	4822	051	30689	68Ω 5% 0.063W 0603 RC21 RST SM
3217	4822	051	30151	150Ω 5% 0.062W
3218	4822	051	30101	100Ω 5% 0.062W
3219	4822	051	30472	4k7 5% 0.062W
3220	4822	051	30472	4k7 5% 0.062W
3221	4822	051	30472	4k7 5% 0.062W
3222	4822	117	13632	100k 1% 0603 0.62W
3223	4822	051	30471	470Ω 5% 0.062W
3224	4822	051	30151	150Ω 5% 0.062W
3225	4822	051	30471	470Ω 5% 0.062W
3226	4822	051	30472	4k7 5% 0.062W
3227	4822	051	30471	470Ω 5% 0.062W
3228	4822	051	30222	2k2 5% 0.062W
3229	4822	051	30689	68Ω 5% 0.063W 0603 RC21 RST SM
3230	4822	051	30759	75Ω 5% 0.062W
3231	4822	051	30561	560Ω 5% 0.062W
3232	4822	051	30101	100Ω 5% 0.062W
3233	4822	051	30471	470Ω 5% 0.062W
3234	4822	051	30339	33Ω 5% 0.062W
3235	4822	051	30689	68Ω 5% 0.063W 0603 RC21 RST SM
3236	4822	051	30472	4k7 5% 0.062W
3237	4822	051	30562	5k6 5% 0

3260	4822 051 30561	560Ω 5% 0.062W
3261	4822 051 30472	4k7 5% 0.062W
3262	4822 051 30759	75Ω 5% 0.062W
3263	4822 051 30472	4k7 5% 0.062W
3264	4822 051 30479	47Ω 5% 0.062W
3266	4822 051 30759	75Ω 5% 0.062W
3267	4822 051 30472	4k7 5% 0.062W
3268	4822 051 30101	100Ω 5% 0.062W
3269	4822 051 30689	68Ω 5% 0.063W 0603 RC21 RST SM
3270	4822 051 30471	470Ω 5% 0.062W
3271	4822 051 30759	75Ω 5% 0.062W
3272	4822 051 30273	27k 5% 0.062W
3273	4822 117 12925	47k 1% 0.063W 0603
3275	4822 051 30272	2k7 5% 0.062W
3276	4822 051 30472	4k7 5% 0.062W
3277	4822 051 30561	560Ω 5% 0.062W
3278	4822 051 30561	560Ω 5% 0.062W



6208 9340 548 63115 PDZ15B



7102	4822 130 60511	BC847B
7103	4822 130 60511	BC847B
7104	4822 130 60511	BC847B
7105	4822 130 60511	BC847B
7106	4822 130 40854	BC327
7200	4822 130 42804	BC817-25
7201	4822 130 42804	BC817-25
7202	4822 130 60511	BC847B
7203	4822 130 60511	BC847B
7204	4822 130 60511	BC847B
7205	4822 130 60373	BC856B
7206	4822 130 60511	BC847B
7207	4822 130 60511	BC847B
7208	4822 130 60511	BC847B
7209	4822 130 60511	BC847B
7210	4822 130 42804	BC817-25
7211	4822 130 42804	BC817-25
7212	4822 130 60511	BC847B
7213	4822 130 60373	BC856B
7214	4822 130 60511	BC847B
7215	4822 130 42804	BC817-25
7216	4822 130 42804	BC817-25
7217	4822 130 60511	BC847B
7218	4822 130 60511	BC847B
7219	4822 130 42804	BC817-25
7220	4822 130 42804	BC817-25
7500	9322 134 86668	LF80C
7501	9322 135 59671	STV6411AD